

ARO®

Piston Pumps



Distributed by:



ユニツール株式会社

東京都多摩市関戸4丁目8番地18
〒206-0011 TEL: 042-376-8747
FAX: 042-376-8748

www.AROzone.com

aro hotline@irco.com

youtube.com/aropumps

ARO®

ARO® is a brand of Ingersoll Rand. Ingersoll Rand (NYSE:IR) advances the quality of life by creating comfortable, sustainable and efficient environments. Our people and our family of brands—including Club Car®, Ingersoll Rand®, Thermo King® and Trane®—work together to enhance the quality and comfort of air in homes and buildings; transport and protect food and perishables; and increase industrial productivity and efficiency. We are a \$12 billion global business committed to a world of sustainable progress and enduring results.

We are committed to using environmentally conscious print practices

©2014 Ingersoll Rand F-0501614-EN

IR Ingersoll Rand®



Technical symbols

In the event of difficulty of interpretation, please refer to the following list to know the exact significance.

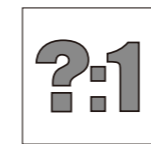

Ratio



Maximum flow per minute



Displacement per cycle

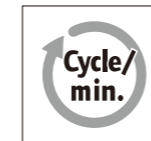

Max. cycles per minute



Cycles per litre



Fluid pressure range

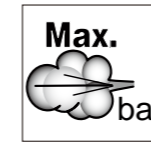

Max. air pressure



Hydraulic inlet connection



Hydraulic return connection



Pump motor diameter



Weight



Air inlet connection

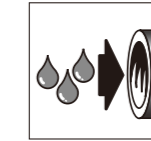

Fluid inlet connection



Fluid outlet connection



ATEX certified model



Sound level

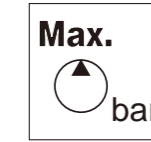

Max. hydraulic pressure

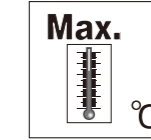

Max. hydraulic temperature

Applications of the piston pumps

Piston Pumps are used in a wide variety of fluid handling applications. The majority of these can be broken into four different categories:

- **Transfer**
Simple transfer involves moving a low-to-medium viscosity fluid from one location to another. 2-ball and 4-ball style pumps are most frequently used in transfer applications.
- **Extrusion**
Extrusion involves using a Piston Pump to apply medium-to-high viscosity materials. Typical extrusion applications require accessories like rams and fluid regulators to meet customer requirements. Chop-Check and 2-ball pumps are used in extrusion applications.
- **Coating Application**
This involves application of a material by either spray or dipping. Coating applications use 2-ball and 4-ball pumps.
- **Measuring/Dispense**
Measuring and Dispense involves the delivery of a specified quantity of fluid on a repetitive basis. Measuring/Dispense applications use 2-ball, 4-ball and Chop-Check pumps.



Materials of Construction

Pump components are constructed of different materials to ensure the pump is best suited to a particular application:

- **Pump Body Component Options**
Stainless steel: Used with corrosive fluids and water-borne materials. Stainless steel is resistant to corrosion. It can be heat-treated, hard chrome-plated or Ultra-Coated™ to improve abrasion resistance.
Carbon steel: Provides excellent abrasion resistance. Can be heat-treated and hard chrome-plated. Not suited for water-borne fluids and corrosive materials, as it will rust and deteriorate.
- **Packings**
Used to seal movement of the plunger rod. The upper (throat) packings seal the rod as it moves through the outlet casting. The lower (piston) packings seal the piston as it reciprocates within the pump body.
Packings are made of different materials to ensure chemical and material compatibility to maximize service life. Using packings of different material combinations can often improve service life by utilizing the strengths of both materials.
- **UHMW-PE (Ultra-High Molecular Weight Polyethylene):**
An all-purpose packing material that provides excellent abrasion resistance. Commonly used with inks, acids and some solvents.
- **Teflon®***
Compatible with all fluids. Provides excellent corrosion resistance but poor abrasion resistance. Commonly used with corrosive chemicals, ketone, acids and room-temperature vulcanizing (RTV) materials.
- **Leather**
Commonly used in combination with UHMW-PE packings for excellent sealing and abrasion resistance. UHMW-PE and leather is most often used when pumping ink.

Contents

Piston Pumps



2-ball piston pumps

1



4-ball piston pumps

2



Chop check extrusion piston pumps

3

Specialized pumps



Piston pump accessories

4



Lubrication pumps and accessories

5



Specialty application pumps

6



Hydraulic Pumps

7

Pump-to-Fluid Viscosity Guide

Considerations:

The chart should only be used as a guide, and not as an absolute solution to a pump problem. It does not take into consideration Vpressure losses due to sizes and lengths of hoses, piping runs, dispensing valves, hose swivels, elevations, and other restriction factors.

| Flow | Maximum Delivery Rate gpm (L/min) | Ratio | Fluid Pressure Range psi (bar) | Material of Construction | Lower End Type | Pump on Page | 500 | 1,000 | 5,000 | 7,500 | 10,000 | 12,500 | 15,000 | 20,000 | 35,000 | 50,000 | 75,000 | 100,000 | 250,000 | 500,000 | 750,000 | 1,000,000 | | |
|-----------|--------------------------------------|----------------------------|-----------------------------------|-----------------------------|----------------|--------------|--------|-------|-------|---------------|---------------|--------|--------|--------|-------------|-------------|--------|---------|---------|---------|---------|-----------|--|--|
| 0 - 2 | 0.38 (1.4) | 28:1 | 0 - 4200 (0 - 289.6) | Stainless steel | 2-ball | 15 | Siphon | | | Flooded inlet | | | | | | | | | | | | | | |
| | 0.5 (1.9) | 22:1 | 0 - 3300 (0 - 227.5) | Carbon steel | Chop-check | 13 | | | | Flooded inlet | | | | | | Ram Mounted | | | | | | | | |
| | 0.5 (1.9) | 22:1 | 0 - 3300 (0 - 227.5) | Stainless steel | Chop-check | 13 | | | | Flooded inlet | | | | | | Ram Mounted | | | | | | | | |
| | 0.74 (2.8) | 43:1 | 0 - 6549 (0 - 451.5) | Stainless steel | Chop-check | 61 | | | | Flooded inlet | | | | | | Ram Mounted | | | | | | | | |
| | 0.74 (2.8) | 43:1 | 0 - 6549 (0 - 451.5) | Carbon steel | Chop-check | 61 | | | | Flooded inlet | | | | | | Ram Mounted | | | | | | | | |
| | 0.6 (2.3) | 18:1 | 0 - 2700 (0 - 186.2) | Stainless steel | 2-ball | 12 | Siphon | | | | Flooded inlet | | | | | | | | | | | | | |
| | 1.3 (4.9) | 30:1 | 900 - 4629 (62.1 - 319.2) | Stainless steel | 2-ball | 33 | Siphon | | | | Flooded inlet | | | | | Ram Mounted | | | | | | | | |
| | 1.3 (5.1) | 65:1 | 0 - 7475 (0 - 515) | Carbon steel | Chop-check | 69 | | | | | Flooded inlet | | | | | Ram Mounted | | | | | | | | |
| | 1.4 (5.4) | 60:1 | 1800 - 6172 (124.1 - 425.5) | Stainless steel | 2-ball | 39 | Siphon | | | | Flooded inlet | | | | | Ram Mounted | | | | | | | | |
| | 1.5 (5.7) | 3.6:1 Hyd | 180 - 4320 (12.4 - 297.9) | Carbon steel | Chop-check | 110 | | | | | Flooded inlet | | | | | Ram Mounted | | | | | | | | |
| | 1.6 (6.1) | 3.3:1 Hyd | 165 - 3394 (11.4 - 234) | Stainless steel | 2-ball | 109 | Siphon | | | | Flooded inlet | | | | | Ram Mounted | | | | | | | | |
| | 1.8 (6.9) | 23:1 | 0 - 3690 (0 - 254.4) | Carbon steel | Chop-check | 54 | | | | | Flooded inlet | | | | | Ram Mounted | | | | | | | | |
| | 1.8 (6.9) | 46:1 | 0 - 7485 (0 - 516.1) | Carbon steel | Chop-check | 67 | | | | | Flooded inlet | | | | | Ram Mounted | | | | | | | | |
| | 1.9 (7.3) | 22:1 | 660 - 3412 (45.5 - 235.3) | Stainless steel | 2-ball | 26 | Siphon | | | | Flooded inlet | | | | | Ram Mounted | | | | | | | | |
| 1.9 (7.3) | 45:1 | 1350 - 5459 (93.1 - 376.4) | Stainless steel | 2-ball | 37 | Siphon | | | | Flooded inlet | | | | | Ram Mounted | | | | | | | | | |
| 0 - 4 | 2.1 (8) | 4:1 | 0 - 600 (0 - 41.4) | Stainless steel | 2-ball | 11 | Siphon | | | Ram Mounted | | | | | | | | | | | | | | |
| | 2.1 (8.1) | 2:1 | 0 - 351 (0 - 24.2) | Carbon steel | 2-ball | 8 | Siphon | | | Flooded inlet | | | | | | | | | | | | | | |
| | 2.1 (8.1) | 2:1 | 0 - 351 (0 - 24.2) | Stainless steel | 2-ball | 9 | Siphon | | | Flooded inlet | | | | | | | | | | | | | | |
| | 2.1 (8) | 4:1 | 0 - 600 (0 - 41.4) | Carbon steel | 2-ball | 10 | Siphon | | | Ram Mounted | | | | | | | | | | | | | | |
| | 2.7 (10.2) | 2:1 Hyd | 100 - 2400 (6.9 - 165.5) | Carbon steel | Chop-check | 108 | | | | | Flooded inlet | | | | | Ram Mounted | | | | | | | | |
| | 2.9 (10.8) | 9:1 | 0 - 1350 (0 - 93.1) | Stainless steel | 2-ball | 20 | | | | | Flooded inlet | | | | | | | | | | | | | |
| | 2.8 (10.5) | 9:1 | 0 - 1350 (0 - 93.1) | Carbon steel | 2-ball | 18 | | | | | Flooded inlet | | | | | | | | | | | | | |
| | 3.1 (11.9) | 0.58:1 Hyd | 85 - 2054 (5.9 - 141.6) | Stainless steel | 2-ball | 105 | Siphon | | | | Flooded inlet | | | | | | | | | | | | | |
| | 3.2 (12.3) | 23:1 | 0 - 4215 (0 - 290.6) | Carbon steel | Chop-check | 56 | | | | | Flooded inlet | | | | | Ram Mounted | | | | | | | | |
| | 3.2 (12.3) | 12:1 | 0 - 2085 (0 - 143.8) | Carbon steel | Chop-check | 48 | | | | | Flooded inlet | | | | | Ram Mounted | | | | | | | | |
| | 3.7 (14) | 11:1 | 330 - 1747 (22.8 - 120.5) | Stainless steel | 2-ball | 23 | Siphon | | | | Flooded inlet | | | | | Ram Mounted | | | | | | | | |
| | 3.8 (14.3) | 23:1 | 690 - 3495 (47.6 - 241) | Stainless steel | 2-ball | 27 | Siphon | | | | Flooded inlet | | | | | Ram Mounted | | | | | | | | |
| | 3.8 (14.3) | 40:1 | 1200 - 4697 (82.7 - 323.9) | Stainless steel | 2-ball | 35 | Siphon | | | | Flooded inlet | | | | | Ram Mounted | | | | | | | | |
| | 3.8 (14.3) | 44:1 | 1320 - 3964 (91 - 273.3) | Carbon steel | Chop-check | 63 | | | | | Flooded inlet | | | | | Ram Mounted | | | | | | | | |
| 0 - 10 | 4.9 (18.5) | 1:1 | 0 - 150 (0 - 10.3) | Carbon steel | 2-ball | 7 | Siphon | | | | | | | | | | | | | | | | | |
| | 6 (22.7) | 28:1 | 840 - 3360 (57.9 - 231.7) | Carbon steel | Chop-check | 58 | | | | | Flooded inlet | | | | | Ram Mounted | | | | | | | | |
| | 6 (22.9) | 44:1 | 1320 - 3960 (91 - 273) | Carbon steel | Chop-check | 65 | | | | | Flooded inlet | | | | | Ram Mounted | | | | | | | | |
| | 6 (22.9) | 65:1 | 1950 - 5850 (134.5 - 403.3) | Carbon steel | Chop-check | 71 | | | | | Flooded inlet | | | | | Ram Mounted | | | | | | | | |
| | 6.3 (23.7) | 28:1 | 840 - 3360 (57.9 - 231.7) | Stainless steel | 2-ball | 32 | Siphon | | | | Flooded inlet | | | | | Ram Mounted | | | | | | | | |
| | 6.3 (23.7) | 45:1 | 1350 - 4050 (93.1 - 279.2) | Carbon steel | 2-ball | 36 | Siphon | | | | Flooded inlet | | | | | Ram Mounted | | | | | | | | |
| | 6.3 (23.7) | 65:1 | 1950 - 5850 (134.5 - 403.3) | Carbon steel | 2-ball | 41 | Siphon | | | | Flooded inlet | | | | | Ram Mounted | | | | | | | | |
| | 8.7 (33.1) | 1.2:1 Hyd | 60 - 2670 (4.1 - 184.1) | Carbon steel | Chop-check | 107 | | | | | Flooded inlet | | | | | Ram Mounted | | | | | | | | |
| 0 - 20 | 12.2 (46.3) | 13:1 | 390 - 1900 (26.9 - 131) | Carbon steel | Chop-check | 50 | | | | | Flooded inlet | | | | | Ram Mounted | | | | | | | | |
| | 12.2 (46.3) | 20:1 | 600 - 2250 (41.4 - 155.1) | Carbon steel | Chop-check | 52 | | | | | Flooded inlet | | | | | Ram Mounted | | | | | | | | |
| | 12.2 (46.3) | 30:1 | 900 - 3250 (62.1 - 224.1) | Carbon steel | Chop-check | 60 | | | | | Flooded inlet | | | | | Ram Mounted | | | | | | | | |
| | 12.9 (48.8) | 0.8:1 Hyd | 40 - 1600 (2.8 - 110.3) | Stainless steel | 2-ball | 106 | Siphon | | | | Flooded inlet | | | | | | | | | | | | | |
| | 15.6 (58.9) | 10:1 | 300 - 1200 (20.7 - 82.7) | Stainless steel | 2-ball | 22 | Siphon | | | | Flooded inlet | | | | | Ram Mounted | | | | | | | | |
| | 17 (64.4) | 0.3:1 Hyd | 15 - 386 (1 - 26.6) | Stainless steel | 4-ball | 104 | Siphon | | | | Flooded inlet | | | | | | | | | | | | | |
| | 18.1 (68.6) | 15:1 | 450 - 1350 (31 - 93.1) | Stainless steel | 2-ball | 25 | Siphon | | | | Flooded inlet | | | | | Ram Mounted | | | | | | | | |
| | 18.1 (68.6) | 23:1 | 690 - 2070 (47.6 - 142.7) | Stainless steel | 2-ball | 31 | Siphon | | | | Flooded inlet | | | | | | | | | | | | | |
| 0 - 35 | 21.3 (80.6) | 2:1 | 60 - 312 (4.1 - 21.5) | Stainless steel | 4-ball | 43 | Siphon | | | | Flooded inlet | | | | | | | | | | | | | |
| | 21.3 (80.6) | 4:1 | 120 - 633 (8.3 - 43.6) | Stainless steel | 4-ball | 45 | Siphon | | | | Flooded inlet | | | | | | | | | | | | | |
| | 22.4 (84.9) | 0.2:1 Hyd | 10 - 278 (0.7 - 19.2) | Stainless steel | 4-ball | 103 | Siphon | | | | Flooded inlet | | | | | | | | | | | | | |
| | 23.5 (88.8) | 7:1 | 210 - 1009 (14.5 - 69.6) | Stainless steel | 4-ball | 47 | Siphon | | | | Flooded inlet | | | | | | | | | | | | | |
| | 29.3 (110.8) | 3:1 | 90 - 457 (6.2 - 31.5) | Stainless steel | 4-ball | 44 | Siphon | | | | Flooded inlet | | | | | | | | | | | | | |
| | 32.8 (124) | 5:1 | 150 - 702 (10.3 - 48.4) | Stainless steel | 4-ball | 46 | Siphon | | | | Flooded inlet | | | | | | | | | | | | | |

N-Series piston pumps and packages



Motor

Aro's design uses fewer parts in its air motor than the comparable competitive industrial pump. With fewer parts come fewer problems, it's really just that simple.

Over 10 Million Cycles: in field tests under rigorous, real-world working conditions, the new N-Series pumps have turned over more than 10-million cycles-and are still running!

Patented ARO® Stall-Free, Ice-Free Air Motor Design: Your guarantee of trouble-free pump operation. The N Series air motor contains fewer parts and requires absolutely no mechanical assist devices such as trip rods or push pins.



Ease of installation: air inlet and fluid outlet can be oriented in 90° increments.



Groundable, ATEX-compliant

Lubrication-free operation

Piston pump types

The N-Series pumps are available in 2 balls and chop-check versions. The diagram illustrates the recommended working ranges, according to the fluid viscosity and the desired flow.

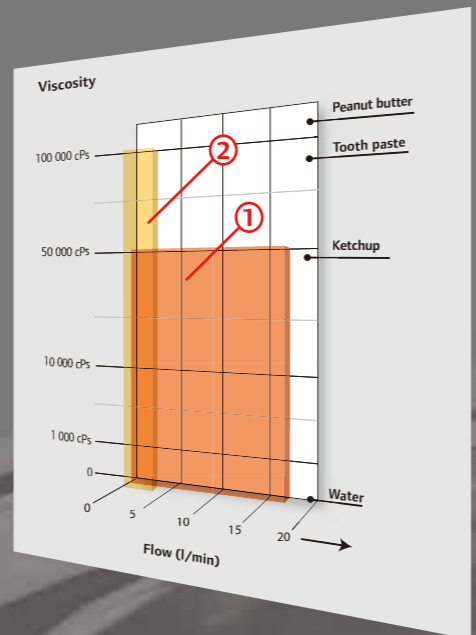
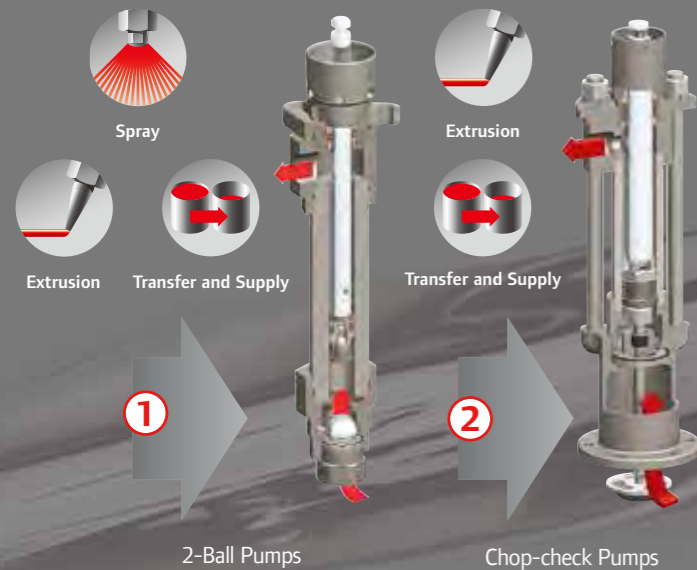

Pump lowers are available in two distinct alloys for today's tough fluid material demands. They fit on 20 L or 200 L drum and can also be installed on wall bracket.

1:1
18.5 l/min

N Series

2-ball piston pump

| Specifications | | | |
|----------------|--------------------|-------------|----------------------------|
| Ratio | 1:1 | Max. bar | 0 - 10 bar |
| Motor | 2" (51 mm) | Cycle/min. | 75 cycles/min. |
| Motor | 6" (152 mm) | 1 min. | 18 l/min. @ 60 cycles/min. |
| AIR | 1/4" NPT(F) | 1 cycle | 308 cc |
| Max. bar | 0 - 10.3 bar | For 1 litre | 3.3 cycles |
| Headphones | 77.8 dBA @ 6.9 bar | Immersed | |
| Weight | 5.9 kg | | 3/4" NPT(F) |



Transfer and Supply

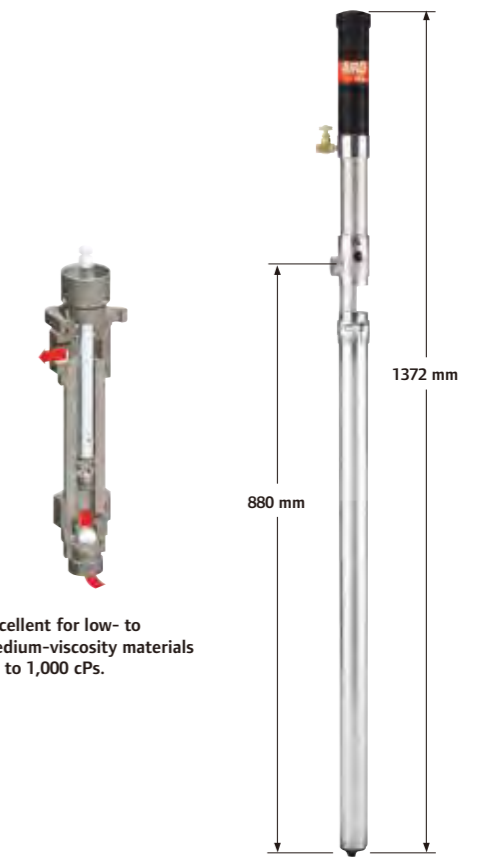

Excellent for low- to medium-viscosity materials up to 1,000 cPs.

| Pump model no. | Type | Plunger material | Packings (upper + lower) | ServiceKit (1) |
|--------------------------|--------------------|------------------|--------------------------|----------------|
| Carbon steel pump | | | | |
| 612041-1 | Wall mount or drum | Carbon steel | PTFE + PTFE | 637081 |
| 612041-3 | | | Buna | 637083 |

(1) Lower pump repair kit

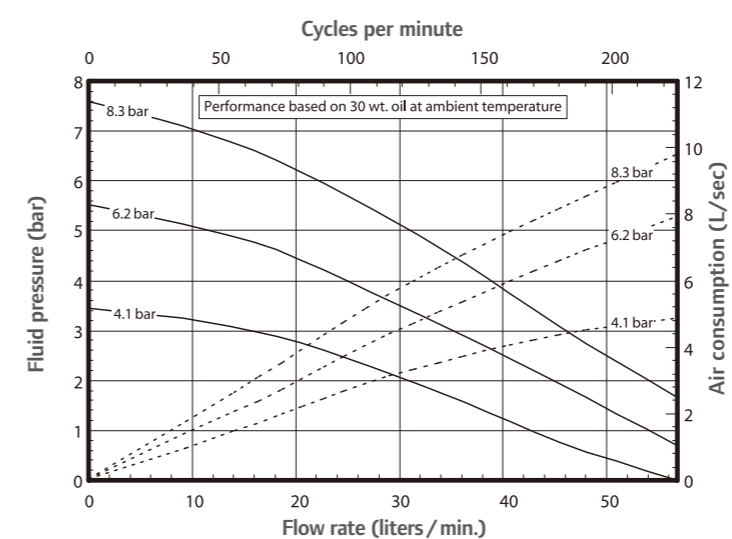

| Pump accessories | | |
|------------------|--------------------------|--|
| P39124-600 | Air Filter and Regulator | |
| 61113 | Wall mount bracket | |
| 61879 | Muffler | |
| 104104-N02 | Needle valve | |
| 635040 | AroStop valve assembly | |
| 637084 | Motor service kit | |

2:1
8.1 l/min

N Series

2-ball piston pump

| Specifications | | | |
|----------------|---|--|---|
| | 2:1 | | 4 - 21 bar |
| | 2" (51 mm) | | 120 cycles/min. |
| | 3" (76 mm) | | 8 l/min. @ 60 cycles/min. |
| | 1/4" NPT(F) | | 135 cc |
| | 2 - 10.3 bar | | 7.4 cycles |
| | 80 dBA @ 6.9 bar | | 1 1/2" NPTF (NM2202A-11...) 1 1/4" NPTF (NM2202B-11...) Immersed (NM2202A-41...) (NM2202B-41...) |
| | NM2202A-11-X31: 7.9 kg NM2202A-41-X31: 8.9 kg NM2202B-11-X31: 7.8 kg NM2202B-41-X31: 10.2 kg | | 3/4" NPT(F) |



Excellent for low- to medium-viscosity materials up to 7,500 cPs.

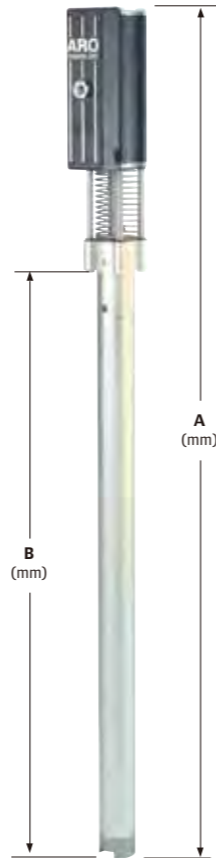

Transfer and Supply

| | A | B |
|----------------|------|-----|
| NM2202A-11-X31 | 868 | 509 |
| NM2202A-41-X31 | 1215 | 856 |
| NM2202B-11-X31 | 860 | 504 |
| NM2202B-41-X31 | 1212 | 856 |

| Pump model no. | Type | Lower pump | Plunger material | Packings (upper + lower) | ServiceKit (1) |
|--------------------------|-------------------|------------|------------------|--------------------------|----------------|
| Carbon steel pump | | | | | |
| NM2202A-11-731 | Stub (wall mount) | 67320-731 | Carbon steel | PTFE + PTFE | 637378-731 |
| NM2202A-11-C31 | | 67320-C31 | | UHMW-PE + UHMW-PE | 637378-C31 |
| NM2202A-11-J31 | | 67320-J31 | | Polyurethane + UHMW-PE | 637378-J31 |
| NM2202A-41-731 | For 200 L drum | 67319-731 | | PTFE + PTFE | 637378-731 |
| NM2202A-41-C31 | | 67319-C31 | | UHMW-PE + UHMW-PE | 637378-C31 |
| NM2202A-41-J31 | | 67319-J31 | | Polyurethane + UHMW-PE | 637378-J31 |

(1) Lower pump repair kit

See stainless steel models on following page.

2:1
8.1 l/min

N Series

2-ball piston pump (continued)

| Pump model no. | Type | Lower pump | Plunger material | Packings (upper + lower) | ServiceKit (1) |
|-----------------------------|-------------------|------------|----------------------------|--------------------------|----------------|
| Stainless steel pump | | | | | |
| NM2202B-11-731 | Stub (wall mount) | 67318-731 | 300 Series stainless steel | PTFE + PTFE | 637379-731 |
| NM2202B-11-C31 | | 67318-C31 | | UHMW-PE + UHMW-PE | 637379-C31 |
| NM2202B-11-J31 | | 67318-J31 | | Polyurethane + UHMW-PE | 637379-J31 |
| NM2202B-41-731 | For 200 L drum | 67317-731 | | PTFE + PTFE | 637379-731 |
| NM2202B-41-C31 | | 67317-C31 | | UHMW-PE + UHMW-PE | 637379-C31 |
| NM2202B-41-J31 | | 67317-J31 | | Polyurethane + UHMW-PE | 637379-J31 |

(1) Lower pump repair kit

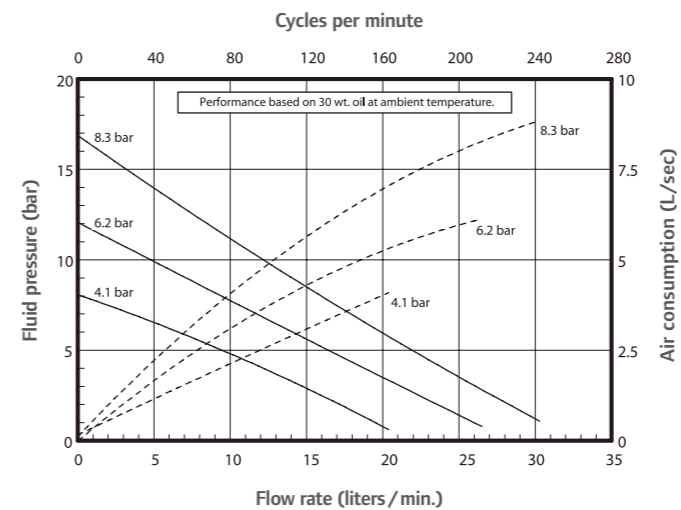

| Pump accessories | |
|------------------|--------------------------|
| P39124-600 | Air Filter and Regulator |
| 104104-N02 | Needle valve |
| 66073-1 | Air line connection kit |
| 635040 | AroStop valve assembly |
| 61113 | Wall mount bracket |
| 637377 | Motor service kit |

4:1

8 l/min

N
Series

2-ball piston pump

| Specifications | | | |
|------------------|--|--|---------------------------|
| ?:1 | 4:1 | Max. bar | 8 - 41 bar |
| Motor | 3" (76 mm) | Cycle/min | 125 cycles/min. |
| Motor | 3" (76 mm) | 1 min. | 8 l/min. @ 60 cycles/min. |
| AIR | 1/4" NPT(F) | 1 cycle | 135 cc |
| Max. bar | 0 - 10.3 bar | For 1 litre | 7.4 cycles |
| 85 dBA @ 6.9 bar | | 1 1/2" NPTF (NM2304A-11...) 1 1/4" NPTF (NM2304B-X1...) | |
| Weight | NM2304A-11-X11: 14.5 kg NM2304A-41-X11: 20.9 kg NM2304B-11-X11: 14.5 kg NM2304B-41-X11: 20.9 kg | 3/4" NPT(F) | |



Excellent for low- to medium-viscosity materials up to 20,000 cPs.

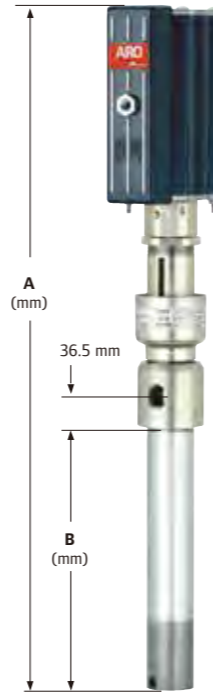

| | A (mm) | B (mm) |
|----------------|--------|--------|
| NM2304A-11-X11 | 769 | 298 |
| NM2304A-41-X11 | 1 413 | 942 |
| NM2304A-81-X11 | 769 | 298 |
| NM2304A-91-X11 | 1 413 | 942 |
| NM2304A-A1-X11 | 751 | 280 |

See stainless steel models on following page.

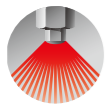

Spray



Extrusion



Transfer and Supply

| Pump model no. | Type | Lower pump | Plunger material | Packings (upper + lower) | ServiceKit (1) |
|--------------------------|------------------------------|-------------|------------------|---|----------------|
| Carbon steel pump | | | | | |
| NM2304A-11-C11 | | 67151-1-C11 | | UHMW-PE + UHMW-PE | 637228 |
| NM2304A-11-311 | Stub (wall mount) | 67151-1-311 | | Glass-filled PTFE + Virgin PTFE | 637176 |
| NM2304A-11-511 | | 67151-1-511 | | Glass-filled PTFE / leather + Virgin PTFE | 637176 |
| NM2304A-81-311 | Stub, without bung | 67151-8-311 | | Glass-filled PTFE + Virgin PTFE | 637176 |
| NM2304A-41-C11 | | 67151-4-C11 | | UHMW-PE + UHMW-PE | 637228 |
| NM2304A-41-311 | For 200 L drum | 67151-4-311 | Carbon steel | Glass-filled PTFE + Virgin PTFE | 637176 |
| NM2304A-41-511 | | 67151-4-511 | | Glass-filled PTFE / leather + Virgin PTFE | 637176 |
| NM2304A-91-311 | For 200 L drum, without bung | 67151-9-311 | | Glass-filled PTFE + Virgin PTFE | 637176 |
| NM2304A-A1-C11 | | 67151-A-C11 | | UHMW-PE + UHMW-PE | 637228 |
| NM2304A-A1-311 | Stub, for follower plate | 67151-A-311 | | Glass-filled PTFE + Virgin PTFE | 637176 |
| NM2304A-A1-511 | | 67151-A-511 | | Glass-filled PTFE / leather + Virgin PTFE | 637176 |

(1) Lower pump repair kit

4:1

8 l/min

N
Series

2-ball piston pump (continued)

| Pump model no. | Type | Lower pump | Plunger material | Packings (upper + lower) | ServiceKit (1) |
|---------------------------------|-------------------|------------|---------------------------------------|---------------------------------|----------------|
| 316 stainless steel pump | | | | | |
| NM2304B-11-C11 | | 65108-4 | | UHMW-PE + UHMW-PE | 637010-4 |
| NM2304B-11-311 | | 65108 | 316 stainless steel | Glass-filled PTFE + Virgin PTFE | 637010 |
| NM2304B-11-W11 | Stub (Wall mount) | 65108-8 | | Viton® + virgin PTFE | 637010-6 |
| NM2304B-11-C1B | | 65108-6 | 316 stainless steel / ceramic coating | UHMW-PE + UHMW-PE | 637010-4 |
| NM2304B-11-31B | | 65108-5 | | Glass-filled PTFE + Virgin PTFE | 637010 |
| NM2304B-41-C11 | For 200 L drum | 65106-4 | 316 stainless steel | UHMW-PE + UHMW-PE | 637010-4 |
| NM2304B-41-311 | | 65106 | | Glass-filled PTFE + Virgin PTFE | 637010 |

(1) Lower pump repair kit

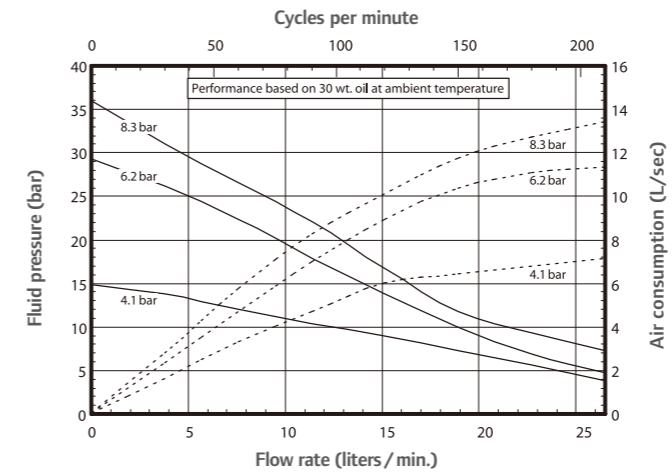

66334-B

66333-B
WetSol, pump upper packing lubricant - 1 liter

66334-B
WetSol, pump upper packing lubricant - 3.8 liters

Recommended for use in piston pumps solvent cups – Increase the performance and service life of pumping equipment.

Pump accessories

| | | |
|------------|--------------------------|--|
| P39124-600 | Air Filter and Regulator | |
| 104104-N02 | Needle valve | |
| 66073-1 | Air line connection kit | |
| 635040 | AroStop valve assembly | |
| 61113 | Wall mount bracket | |
| 637316 | Motor service kit | |

18:1

2.3 l/min

N Series

2-ball piston pump

| Specifications | | | |
|-------------------------|--------------|--------------------|-----------------------------|
| ?:1 | 18:1 | Max. bar | 35 - 185 bar |
| Motor | 3" (76 mm) | Cycle/min. | 120 cycles/min. |
| Motor | 3" (76 mm) | 1 min. | 2.3 l/min. @ 60 cycles/min. |
| AIR | 1/4" NPT(F) | 1 cycle | 38.5 cc |
| Max. bar | 2 - 10.3 bar | For 1 litre | 26.5 cycles |
| 85 dBA @ 6.9 bar | | | 1/2" NPT(F) |
| 5.7 kg | | | 1/4" NPSM |

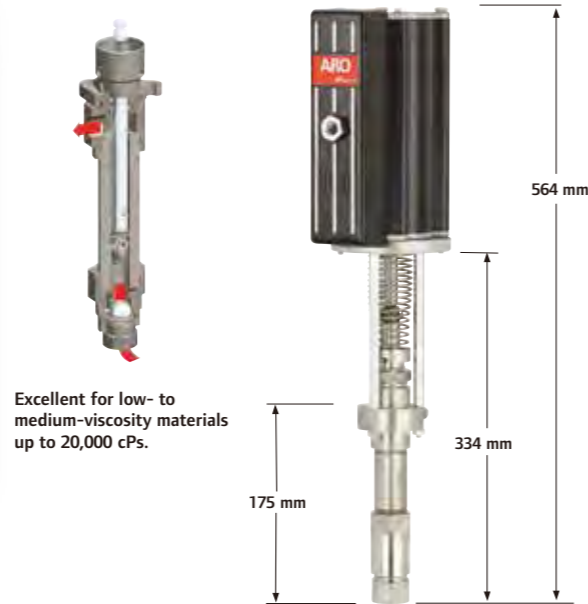

| Pump model no. | Type | Lower pump | Plunger material | Packings (upper + lower) | ServiceKit (1) |
|---------------------------------|-------------------|--------------|-----------------------------------|-------------------------------------|----------------|
| 400 stainless steel pump | | | | | |
| NM2318B-13-C43 | Stub (wall mount) | 67310-13-C43 | 400 stainless steel / hard chrome | UHMW-PE (upper & lower) | 637394-C43 |
| NM2318B-13-L43 | | 67310-13-L43 | | Mineral-filled PTFE (upper & lower) | 637394-L43 |

(1) Lower pump repair kit

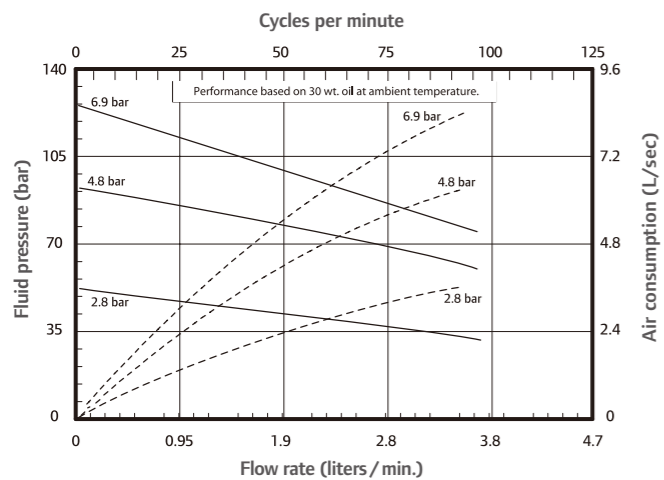

| Pump accessories | |
|------------------|--------------------------|
| P39124-600 | Air Filter and Regulator |
| 104104-N02 | Needle valve |
| 66073-1 | Air line connection kit |
| 635040 | AroStop valve assembly |
| 95015 | Wall mount bracket |
| 637316 | Motor service kit |

22:1

1.9 l/min

N Series

Chop Check Extrusion Pump

| Specifications | | | |
|-------------------------|-------------------------|--------------------|-----------------------------|
| ?:1 | 22:1 | Max. bar | 44 - 225 bar |
| Motor | 3" (76 mm) | Cycle/min. | 120 cycles/min. |
| Motor | 3" (76 mm) | 1 min. | 1.9 l/min. @ 60 cycles/min. |
| AIR | 1/4" NPT(F) | 1 cycle | 31.1 cc |
| Max. bar | 2 - 10.3 bar | For 1 litre | 32.1 cycles |
| 85 dBA @ 6.9 bar | | | 32.1 cycles |
| | | | 3/4" NPT(F) |
| | NM2322X-11-P4X: 13.2 kg | | |
| | NM2322X-71-P4X: 15.0 kg | | |

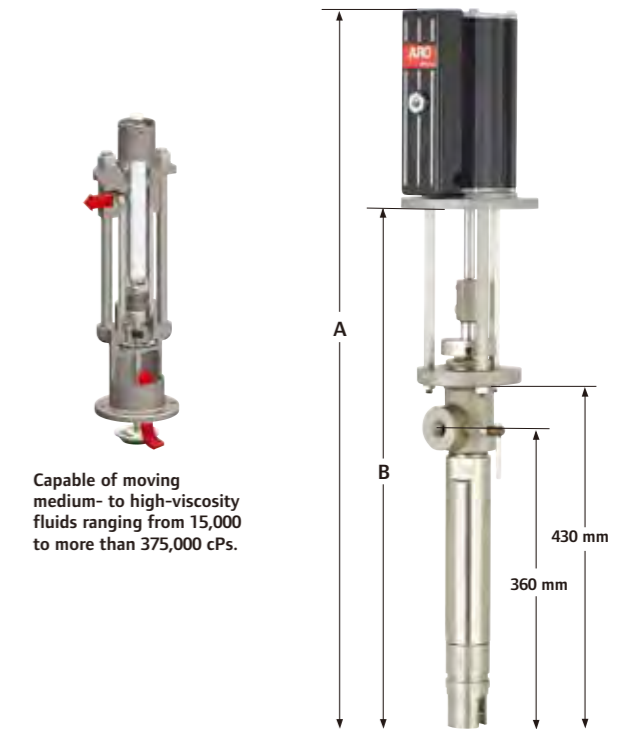

| | A | B |
|----------------|------|-----|
| NM2322X-11-P4X | 844 | 621 |
| NM2322X-71-P4X | 1083 | 847 |

| Pump model no. | Type | Lower pump | Plunger material | Packings (upper + lower) | ServiceKit (1) |
|-----------------------------|-----------------|------------|--|-------------------------------------|----------------|
| Carbon steel pump | | | | | |
| NM2322E-11-P43 | Standard Length | 67100-P43 | 17-4 Stainless steel hard chrome plated | UHMW-PE/glass-filled PTFE + UHMW-PE | 637290-P43 |
| NM2322E-71-P43 | Extended Length | 67100-P43 | | | 637290-P43 |
| NM2322E-11-P48 | Standard Length | 67100-P48 | Hardened stainless steel with alternate piston | UHMW-PE/glass-filled PTFE + UHMW-PE | 637290-P48 |
| NM2322E-71-P48 | Extended Length | 67100-P48 | | | 637290-P48 |
| Stainless steel pump | | | | | |
| NM2322F-11-P43 | Standard Length | 67101-P43 | 17-4 Stainless steel hard chrome plated | UHMW-PE/glass-filled PTFE + UHMW-PE | 637291-P43 |
| NM2322F-71-P43 | Extended Length | 67101-P43 | | | 637291-P43 |
| NM2322F-11-P48 | Standard Length | 67101-P48 | Hardened stainless st. with alternate piston | UHMW-PE/glass-filled PTFE + UHMW-PE | 637291-P48 |
| NM2322F-71-P48 | Extended Length | 67101-P48 | | | 637291-P48 |

(1) Lower pump repair kit

28:1
1.4 l/min

N Series

2-ball piston pump

| Specifications | | | |
|----------------|------------------|--|-----------------------------|
| | 28:1 | | 56 - 288 bar |
| | 3" (76 mm) | | 125 cycles/min. |
| | 3" (76 mm) | | 1.4 l/min. @ 60 cycles/min. |
| | 1/4" NPT(F) | | 23 cc |
| | 0 - 10.3 bar | | 42 cycles |
| | 85 dBA @ 6.9 bar | | 1/2" NPT(F) |
| | 5.9 kg | | 1/4" NPT(M) |

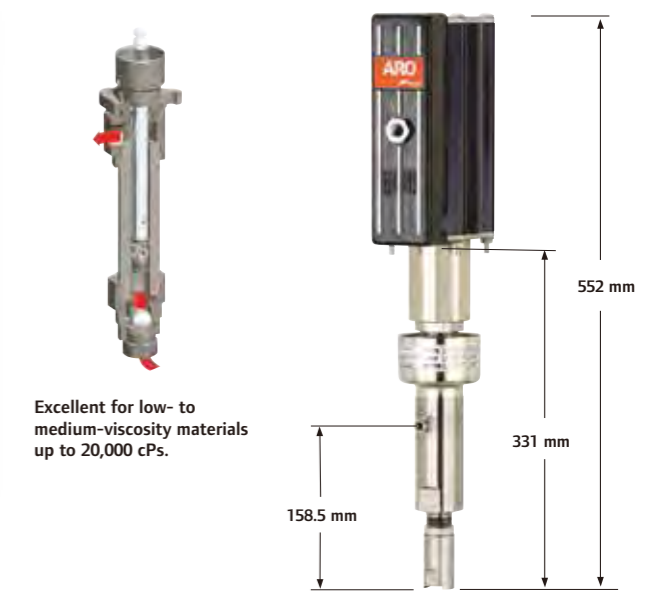

Excellent for low- to medium-viscosity materials up to 20,000 cPs.

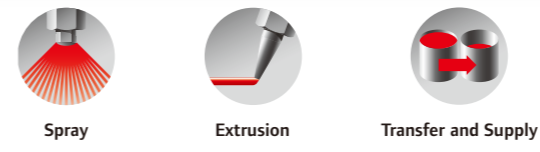

| Pump model no. | Type | Lower pump | Plunger material | Packings (upper + lower) | ServiceKit (1) |
|--------------------------|------|------------|---------------------|---|----------------|
| 440 stainless steel pump | | | | | |
| NM2328A-11-311 | Stub | 66066-1 | 440 stainless steel | Glass-filled PTFE (upper & lower) | 637006-1 |
| NM2328A-11-G11 | | 66066-2 | | UHMW-PE / Leather staggered (upper & lower) | 637006-2 |
| NM2328A-11-S11 | | 66066-3 | | UHMW-PE/glass-filled PTFE staggered (upper & lower) | 637006-3 |

(1) Lower pump repair kit

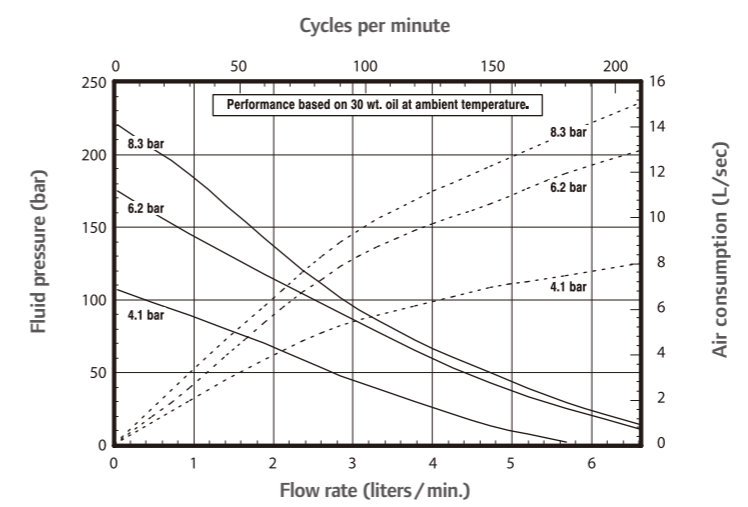

| Pump accessories | | |
|-------------------|--------------------------|--|
| P39124-600 | Air Filter and Regulator | |
| 104104-N02 | Needle valve | |
| 66073-1 | Air line connection kit | |
| 635040 | AroStop valve assembly | |
| 61113 | Wall mount bracket | |
| 637316 | Motor service kit | |

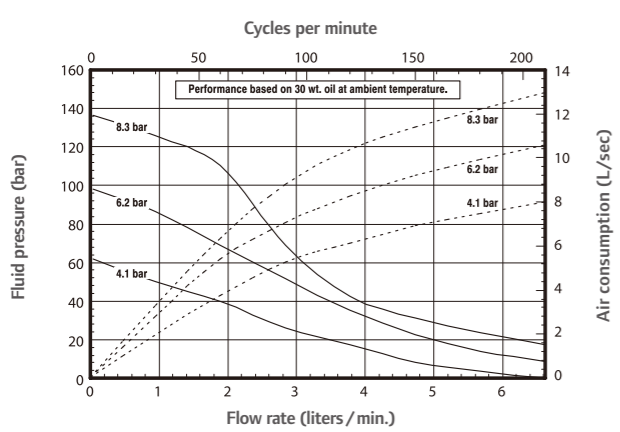

| Pump accessories | | |
|-------------------|--------------------------|--|
| P39124-600 | Air Filter and Regulator | |
| 104104-N02 | Needle valve | |
| 66073-1 | Air line connection kit | |
| 635040 | AroStop valve assembly | |
| 651841-1 | Follower plate | |
| 61113 | Wall mount bracket | |
| 637316 | Motor service kit | |

22:1 ratio extrusion packages for 20 L drum

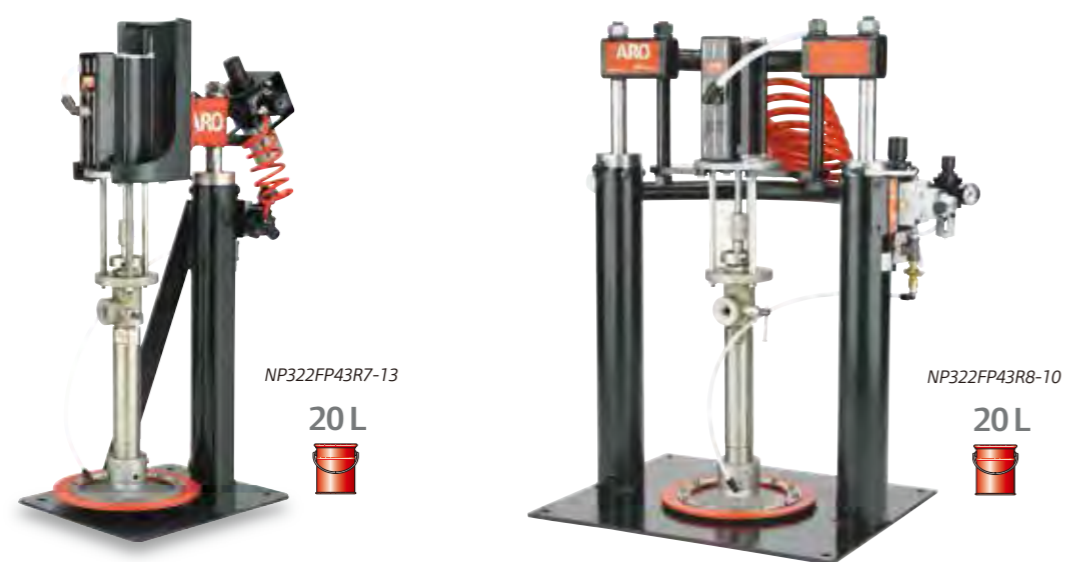

| Model | NP322EP43R7-10 | NP322FP43R7-13 | NP322EP43R8-10 | NP322FP43R8-10 |
|-------------------------------------|-------------------------|-------------------------|-------------------------|-------------------------|
| Pump model | NM2322E-11-P43 | NM2322F-11-P43 | NM2322E-11-P43 | NM2322F-11-P43 |
| Single post RAM (1) | RM051S-C | RM051S-C | — | — |
| Air filter / regulator + Regulator | P39344-100 + R37121-100 | P39344-100 + R37121-100 | — | — |
| Two-post RAM (1) | — | — | RM052S-C | RM052S-C |
| 2 air filter / regulator assemblies | — | — | P39344-100 + P39124-100 | P39344-100 + P39124-100 |
| Carbon steel follower plate | 651840-1 | — | 651840-1 | — |
| Stainless steel follower plate | — | 651841-1 | — | 651841-1 |

(1) Includes RAM and pump air controls.

28:1 ratio pump packages



NP328C01-2



NP328D02-1



NP328D01-3

Cart-mounted pump Pail-mounted pump for 20 L drum & gun Pail-mounted pump for 20 L drum

| Model | NP328 C01-2 | NP328 C02-2 | NP328 D01-1 | NP328 D01-2 | NP328 D02-1 | NP328 D02-2 | NP328 D01-3 | NP328 D01-4 | NP328 D01-6 |
|--------------------------------|-----------------|-----------------|-----------------|-----------------|-----------------|-----------------|-----------------|-----------------|-----------------|
| Pump model | NM2328A -11-S11 | NM2328A -11-S11 | NM2328A -11-G11 | NM2328A -11-S11 | NM2328A -11-G11 | NM2328A -11-S11 | NM2328A -11-G11 | NM2328A -11-S11 | NM2328A -11-S11 |
| Air filter / Regulator | P39124-100 | P39124-100 | — | — | — | — | — | — | — |
| Air regulator | — | — | R37221-100 | R37221-100 | R37221-100 | R37221-100 | — | — | — |
| Inlet hose assembly | 622581-6 | 622581-6 | — | — | — | — | — | — | — |
| Material filter | 651412 | 651412 | 651412 | 651412 | 651412 | 651412 | 651412 | 651412 | 651412 |
| Outlet hose assembly | — | 628042-25 | 628042-25 | 628042-25 | 628042-25 | 628042-25 | — | — | — |
| Airless spray gun | — | 651533 | 651533 | 651533 | 651533 | 651533 | — | — | — |
| Spray nozzle | — | TC1550 | TC-1550 | TC-1550 | TC-1550 | TC-1550 | — | — | — |
| Gun filter and swivel assembly | — | 65030-5-B | 65030-5-B | 65030-5-B | 65030-5-B | 65030-5-B | — | — | — |
| Agitator | — | — | — | — | 650252 | 650252 | — | — | — |
| Bucket | — | — | 65722 | 65722 | 65722 | 65722 | 65722 | 65722 | — |
| Drum cover | — | — | 65706 | 65706 | 65706 | 65706 | 65706 | 65706 | 65706 |
| Pump foot screen | — | — | 90273 | 90273 | 90273 | 90273 | — | — | — |

AFX-Series piston pumps and packages



Motor

The best engineered motor on the market with only 5 moving parts – designed for easy access and maintenance.

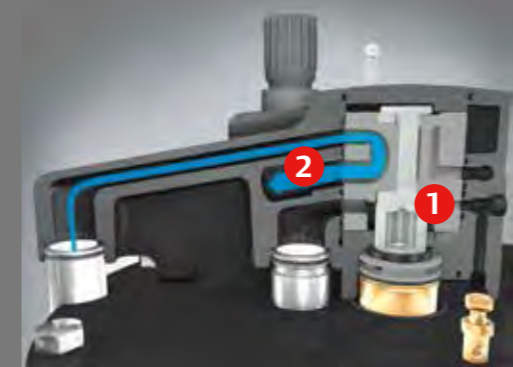

1

True link valve – eliminates pulse profile. Highly polished ceramic plates and PTFE-filled acetal valve components are directly linked to the drive piston. Changeover time is less than one-tenth of a second.

2

Progressive exhaust eliminates variability in pump performance caused by environmental conditions or icing.

Lubrication-free operation

Integrated control block – includes regulator, gauge and shut-off valve. Simplifies installation in a compact space.

Fiber-wound, conductive composite cylinder



ATEX compliant (motors and lower pumps)

Actuation control ports (patent pending)

Universal lower end pump connection

Five motor sizes



Piston pump types

The AFX pumps are available in 2 balls, 4 balls and chop-check versions. The diagram illustrates the recommended working ranges, according to the fluid viscosity and the desired flow.

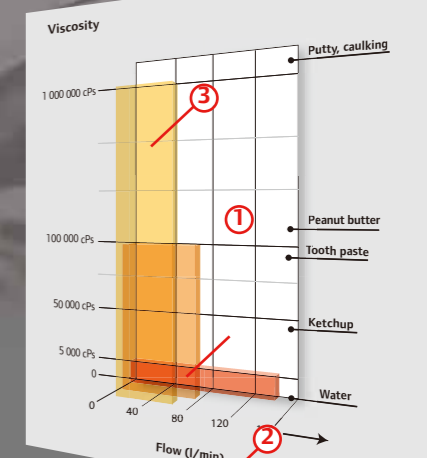
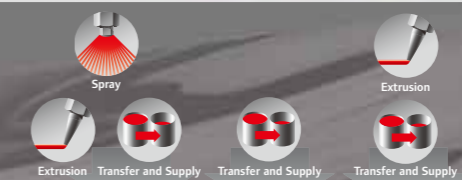

9:1
10.5 l/min

AFX Series

2-ball piston pump

| Specifications | | | |
|-------------------|----------------------------|--------------------------------------|------------------------------|
| Ratio | 9:1 | Max. bar | 0 - 90 bar |
| Motor | 4 1/4" (108 mm) | Cycle/min. | 60 cycles/min. |
| Motor | 4" (102 mm) | 1 min. | 10.5 l/min. @ 60 cycles/min. |
| AIR | 1/2" NPT(F) | 1 cycle | 180 cc |
| Max. bar | 0 - 10.3 bar | For 1 litre | 5.5 cycles |
| Headphones | 80 dBA @ 4.1 bar | Immersed or 1 1/2" NPT(F) (1) | |
| Weight | 15.8 kg 22.2 kg (200 L) | 3/4" NPT(F) | |

(1) Immersed with 20 L and 200 L containers — Remote mounting 1 1/2" fluid inlet.

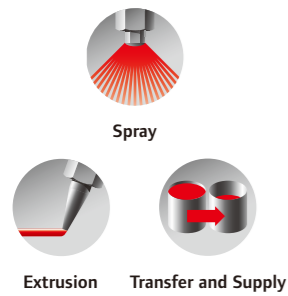

Excellent for low- to medium-viscosity materials up to 20,000 cPs.

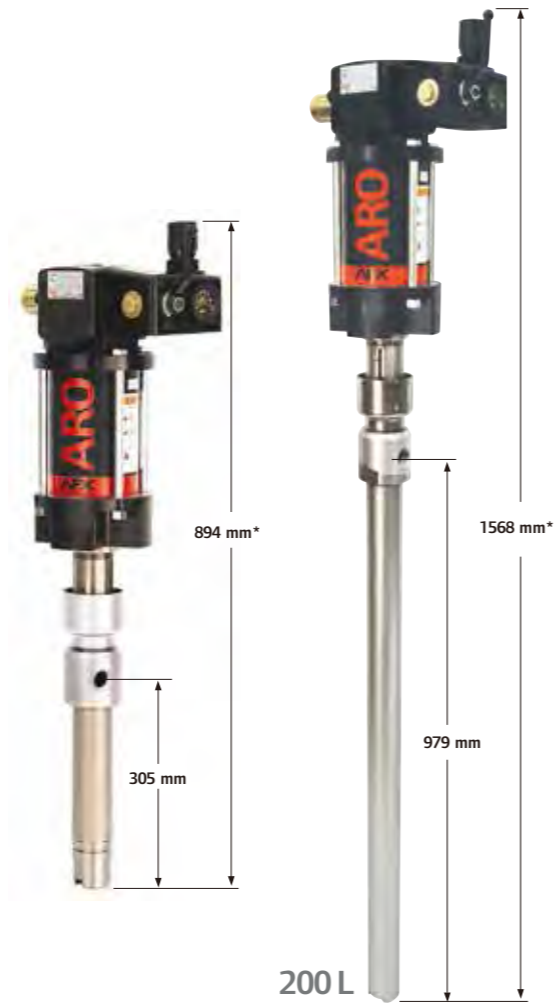

Model shown w/ball valve regulator
*For models without ball valve regulator subtract 52.83mm

| Pump model no. (1) | Lower pump | Plunger material | Packings (upper + lower) | ServiceKit (2) | |
|----------------------------|-------------|------------------|----------------------------|---|--------------|
| For 20 L container | | | | | |
| AF0409A91LL2D | 1875A91LL2D | Carbon steel | Carbon steel | Leather (upper & lower) | K1875A91LL2D |
| For 200 L container | | | | | |
| AF0409A51KS24-02 | 1875A51KS24 | Carbon steel | Carbon steel / hard chrome | Glass-filled PTFE + Virgin PTFE | K1875A11KS24 |
| AF0409A51FF24-02 | 1875A51FF24 | | | UHMW-PE + UHMW-PE | K1875A11FF24 |
| Remote mounting | | | | | |
| AF0409A81KS24-02 | 1875A81KS24 | Carbon steel | Carbon steel / hard chrome | Glass-filled PTFE + Virgin PTFE | K1875A11KS24 |
| AF0409A81US24-02 | 1875A81US24 | | | Glass-filled PTFE / leather + Virgin PTFE | K1875A11US24 |
| AF0409A81HF24-02 | 1875A81HF24 | | | UHMW-PE / Leather + UHMW-PE | K1875A11HF24 |
| AF0409A81FF24-02 | 1875A81FF24 | | | UHMW-PE + UHMW-PE | K1875A11FF24 |

(1) Add "-1" to Model No. for Ball Valve Regulator
(2) Lower pump repair kit

| Pump accessories | |
|------------------|--------------------------------|
| 67445-1 | High performance muffler |
| 23644-400 | AroStop valve |
| 67136 | Floor / follower plate adapter |
| 637489 | Universal motor service kit |
| 67442 | Ball Valve Regulator |

9:1 ratio pump packages



66333-B
WetSol, pump upper packing lubricant - 1 liter

66334-B
WetSol, pump upper packing lubricant - 3.8 liters

66334-B

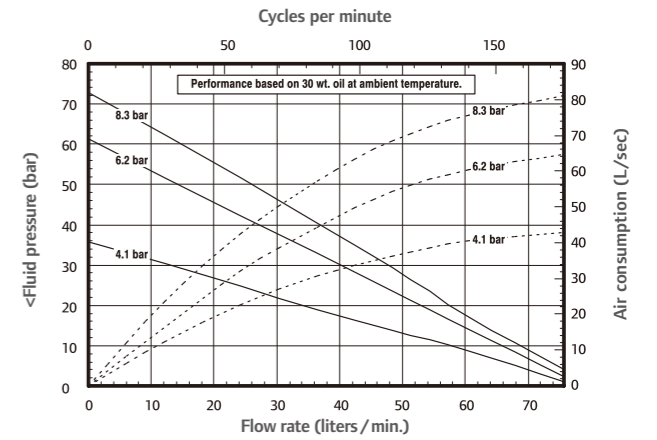

| Model | Type | Pump model | Cart / lift model | Follower plate (model, seal and material) | | Weight |
|----------------------|----------------------|-----------------|-------------------|---|---|-----------------------------|
| CL0409A91LL2DE31 | Cart mount with lift | AF0409A91LL2D-1 | 67075-1-B | 651840-1 | Single-lipped seal, polyethylene / urethane | Carbon steel, nickel plated |
| CL0409A91LL2DE3B (3) | | | | | | |

(3) Includes application kit with control handle and material hose.

| Pump package accessories | |
|--------------------------|----------------|
| F35341-400 | 104317 |
| Air filter | Filter element |



9:1
10.8 l/min

AFX Series

2-ball piston pump

| Specifications | | | |
|---|-----------------|-------------|------------------------------|
| 9:1 | 9:1 | Max. bar | 0 - 90 bar |
| Motor | 4 1/4" (108 mm) | Cycle/min. | 60 cycles/min. |
| Motor | 4" (102 mm) | 1 min. | 10.8 l/min. @ 60 cycles/min. |
| AIR | 1/2" NPT(F) | 1 cycle | 180 cc |
| Max. bar | 0 - 10.3 bar | For 1 litre | 5.5 cycles |
| 89.2 dBA @ 4.1 bar | | | 1 1/4" NPT(F) |
| 15.9 kg (20 L) 20.4 kg (200 L) | | | 3/4" NPT(F) |

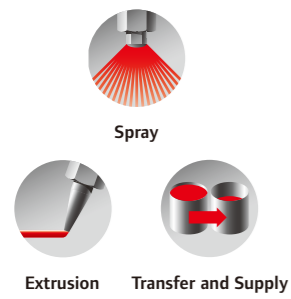

Excellent for low- to medium-viscosity materials up to 20,000 cPs.

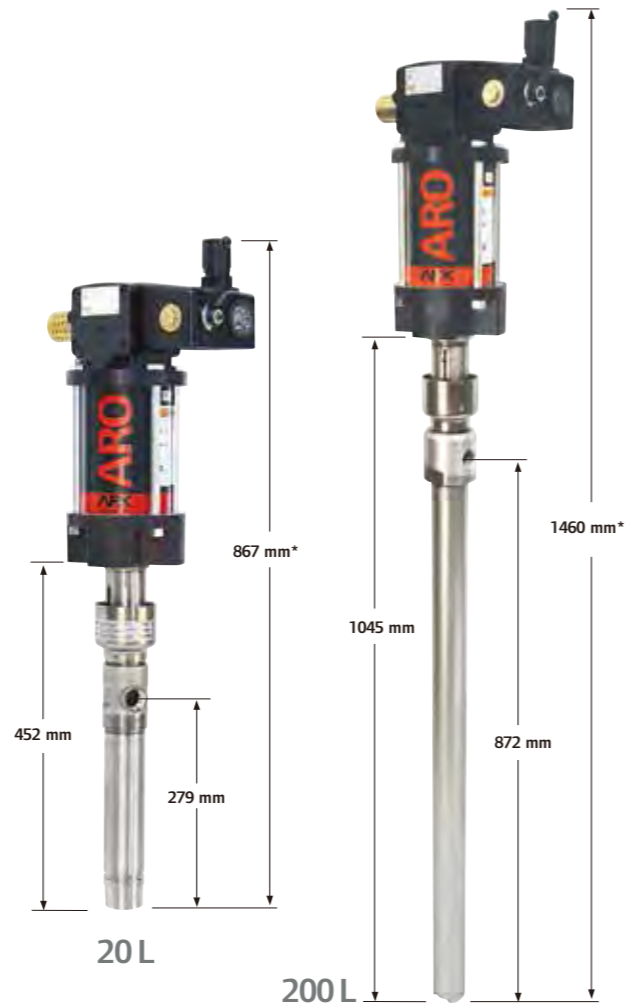

Model shown w/ball valve regulator
*For models without ball valve regulator subtract 52.83mm

| Pump model no. (1) | Lower pump | Plunger material | Packings (upper + lower) | ServiceKit (2) |
|----------------------------|-------------|---------------------|--|----------------|
| For 20 L container | | | | |
| AF0409C11FF22 | 1875C11FF22 | 316 stainless steel | 316 stainless steel | K1875C11FF00 |
| AF0409C11FF29 | 1875C11FF29 | | UHMW-PE + UHMW-PE | K1875C11FF00 |
| AF0409C11SS22 | 1875C11SS22 | 316 stainless steel | 304 stainless steel with ceramic coating | K1875C11SS00 |
| AF0409C11VF2E | 1875C11VF2E | | Virgin PTFE (upper & lower) | K1875C11VF00 |
| AF0409C11VF29 | 1875C11VF29 | | 316 stainless steel, ceramic coated tube | K1875C11VF00 |
| | | | Viton® + UHMW-PE | K1875C11VF00 |
| | | | 304 stainless steel with ceramic coating | K1875C11VF00 |
| For 200 L container | | | | |
| AF0409C51SS22 | 1875C51SS22 | 316 stainless steel | 316 stainless steel | K1875C11SS00 |
| AF0409C51FF22 | 1875C51FF22 | | UHMW-PE + UHMW-PE | K1875C11FF00 |

(1) Add "-1" to Model No. for Ball Valve Regulator
(2) Lower pump repair kit

| Pump accessories | |
|------------------|--------------------------------|
| 67445-1 | High performance muffler |
| 23644-400 | AroStop valve |
| 67136 | Floor / follower plate adapter |
| 637489 | Universal motor service kit |
| 67442 | Ball Valve Regulator |

9:1 ratio pump package

66333-B
WetSol, pump upper packing lubricant - 1 liter

66334-B
WetSol, pump upper packing lubricant - 3.8 liters

66334-B

Recommended for use in piston pumps solvent cups – Increase the performance and service life of pumping equipment.

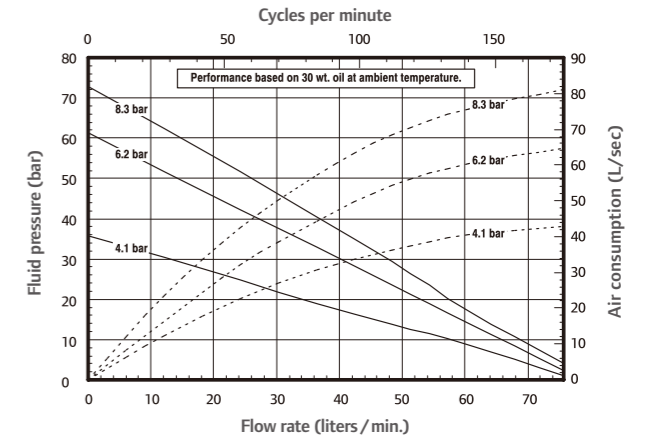

| Model | Type | Pump model | Lift | Drum cover | Material hose | Weight |
|------------------|--|---------------|--------|------------|---------------|---------|
| AL0409C51FF22002 | Pump with drum cover / agitator / lift | AF0409C51FF22 | 640067 | 66197 | 623600-10 | 74.8 kg |

| Pump package accessories | |
|--------------------------|-----------------------------|
| P39344-100 | 104327 |
| Air filter/regulator | Filter/regulator repair kit |



10:1
58.9 l/min

AFX Series

2-ball piston pump

| Specifications | | | |
|-------------------|--------------------|--------------------|------------------------------|
| ?:1 | 10:1 | Max. bar | 0 - 80 bar |
| Motor | 8" (203 mm) | Cycle/min. | 60 cycles/min. |
| Motor | 6" (152 mm) | 1 min. | 58.9 l/min. @ 60 cycles/min. |
| AIR | 3/4" NPT(F) | 1 cycle | 980 cc |
| Max. bar | 0 - 8.3 bar | For 1 litre | 0.98 cycle |
| Headphones | 86.8 dBA @ 4.1 bar | Transfer | 2" NPT(F) |
| Weight | 46.3 kg | Supply | 1 1/4" NPT(F) |

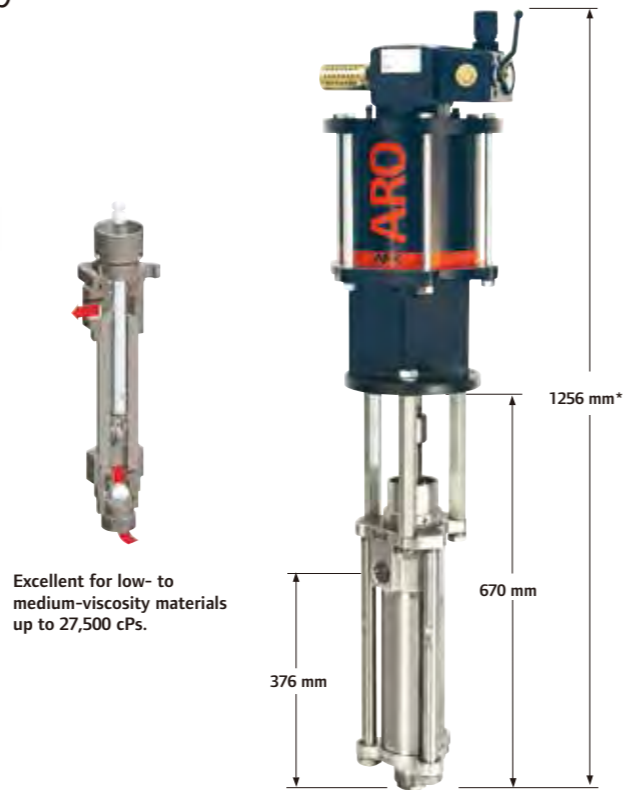

Excellent for low- to medium-viscosity materials up to 27,500 cPs.

Model shown w/ball valve regulator
*For models without ball valve regulator subtract 52.83mm



Spray



Extrusion



Transfer and Supply

| Pump model no. (1) | Lower pump | Plunger material | Packings (upper + lower) | ServiceKit (2) | |
|--------------------|------------|-----------------------------------|---|---|------------|
| AF0810C11CC15 | 66942-K3F | 300 Series / CF8M stainless steel | 321 stainless steel / hard chrome | Carbon-Graphite Filled PTFE (upper & lower) | 637211-K63 |
| AF0810C11FF35 | 66942-C6F | | UHMW-PE + UHMW-PE | 637211-C63 | |
| AF0810C11KK35 | 66942-L6F | | Mineral-filled PTFE (upper & lower) | 637211-L63 | |
| AF0810C11GF35 | 66942-P6F | | UHMW-PE / Mineral-filled PTFE + UHMW-PE | 637211-P63 | |
| AF0810F11FF36 | 66941-C6D | 15-5 stainless steel | 15-5 stainless steel / hard chrome | UHMW-PE + UHMW-PE | 637211-C63 |
| AF0810F11KK36 | 66941-L6D | | Mineral-filled PTFE (upper & lower) | 637211-L63 | |
| AF0810F11RK36 | 66941-R6D | | Mineral-filled PTFE / UHMW-PE + Mineral-filled PTFE | 637211-R63 | |

(1) Add "-1" to Model No. for Ball Valve Regulator

(2) Lower pump repair kit

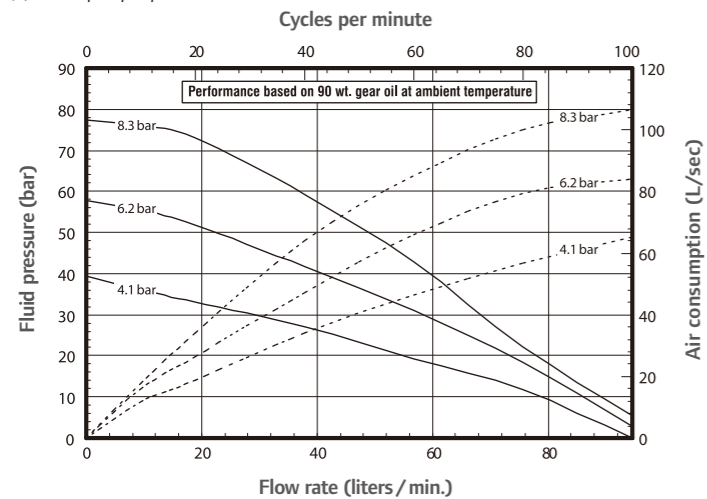

| Pump accessories | |
|------------------|--------------------------------|
| 67445-3 | High performance muffler |
| 635043 | AroStop valve |
| 67136 | Floor / follower plate adapter |
| 637489 | Universal motor service kit |
| 67442 | Ball Valve Regulator |

11:1
14 l/min

AFX Series

2-ball piston pump

| Specifications | | | |
|-------------------|--------------------|--------------------|----------------------------|
| ?:1 | 11:1 | Max. bar | 25 - 120 bar |
| Motor | 4 1/4" (108 mm) | Cycle/min. | 60 cycles/min. |
| Motor | 6" (152 mm) | 1 min. | 14 l/min. @ 60 cycles/min. |
| AIR | 1/2" NPT(F) | 1 cycle | 237.6 cc |
| Max. bar | 2 - 10.3 bar | For 1 litre | 4.2 cycles |
| Headphones | 86.5 dBA @ 4.1 bar | Transfer | 1" NPT(F) / 2" NPT(M) |
| Weight | 19.5 kg | Supply | 1" NPT(F) |

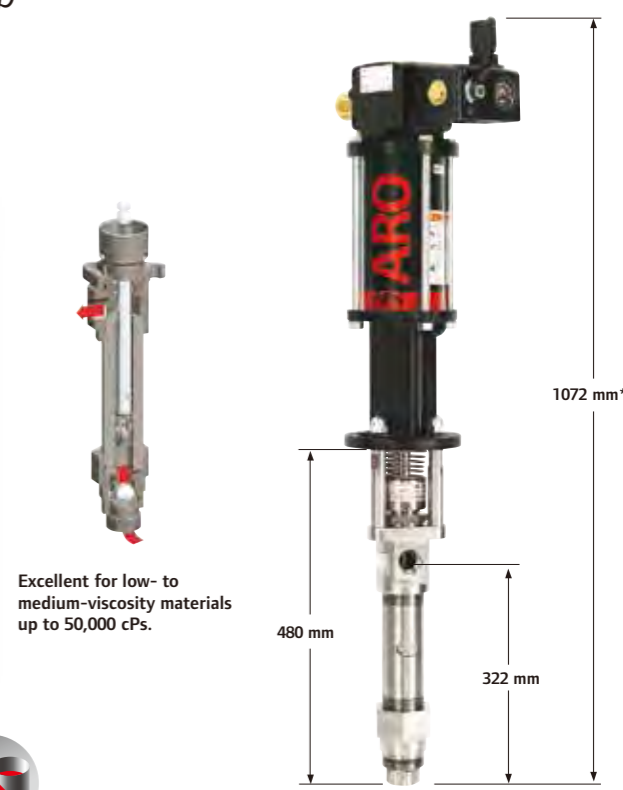

Excellent for low- to medium-viscosity materials up to 50,000 cPs.

Model shown w/ball valve regulator
*For models without ball valve regulator subtract 52.83mm

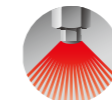

Spray



Extrusion



Transfer and Supply

| Pump model no. (1) | Lower pump | Plunger material | Packings (upper + lower) | ServiceKit (2) |
|--------------------|------------|---|---|----------------|
| AF0411G11FF47 | 66300-C43 | 17-4 stainless steel / hard chrome | UHMW-PE + UHMW-PE | 637305-C43 |
| AF0411G11KK47 | 66300-343 | | Glass-filled PTFE (upper & lower) | 637305-343 |
| AF0411G11KK48 | 66300-34B | | Glass-filled PTFE (upper & lower) | 637305-343 |
| AF0411G11HH47 | 66300-G43 | | UHMW-PE / Leather staggered (upper & lower) | 637305-G43 |
| AF0411G11GF47 | 66300-P43 | 17-4 stainless steel / hard chrome | UHMW-PE/glass-filled PTFE + UHMW-PE | 637305-P43 |
| AF0411G11RK47 | 66300-R43 | | Glass-filled PTFE/UHMW-PE + Glass-filled PTFE | 637305-R43 |
| AF0411G11FF48 | 66300-C4B | | UHMW-PE + UHMW-PE | 637305-C43 |
| AF0411G11GF48 | 66300-P4B | 17-4 stainless steel with ceramic coating | UHMW-PE/glass-filled PTFE + UHMW-PE | 637305-P43 |
| AF0411G11RK48 | 66300-R4B | | Glass-filled PTFE/UHMW-PE + Glass-filled PTFE | 637305-R43 |

(1) Add "-1" to Model No. for Ball Valve Regulator

(2) Lower pump repair kit

| Pump accessories | |
|------------------|--|
| 67445-1 | High performance muffler  |
| 23644-400 | AroStop valve  |
| 67136 | Floor / follower plate adapter  |
| 637489 | Universal motor service kit |
| 67442 | Ball Valve Regulator |

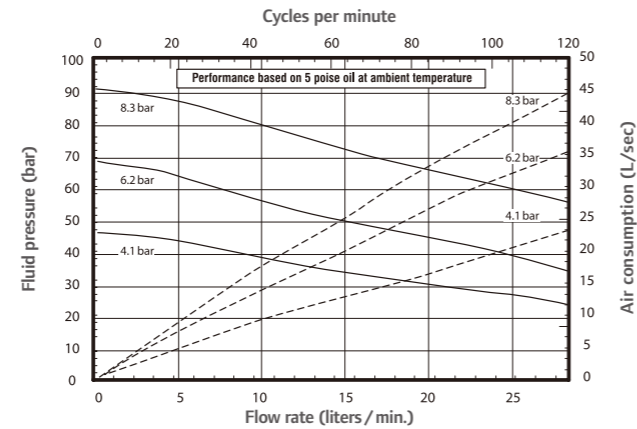

11:1 ratio pump packages



66333-B
WetSol, pump upper packing lubricant - 1 liter

66334-B
WetSol, pump upper packing lubricant - 3.8 liters

66334-B

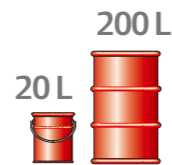

| Model | Type | Pump model | RAM model | Follower plate (model, seal and material) | | Weight | |
|------------------|----------------------|---------------|-----------|---|---------------------------|----------|----------|
| TP0411G21FF48A72 | 20 L / two-post RAM | AF0411G11FF48 | RM052S-C | 67347-2 | Single-tube seal, EPR | Aluminum | 103.3 kg |
| TP0411G21FF48A82 | | | | 67347-1 | Single-tube seal, Buna | Aluminum | |
| TP0411G51GF47AA2 | 200 L / two-post RAM | AF0411G11GF47 | RM552S-C | 66516-1 | Double lip / polyurethane | Aluminum | 177.2 kg |

| Pump package accessories | | | |
|--------------------------|---|---|---|
| 66354-1 | 67480 (20 L) 67481 (200 L) | 67500 (20 L) 67501 (200 L) | 637466 (20 L) 637472 (200 L) |
| Pump stabilizing bracket | Cross over kit | Low-level cut-off kit | Two-post RAM repair kit |

15:1
68.6 l/min

AFX Series

2-ball piston pump

| Specifications | | | |
|----------------------|------------------------------------|---------------------------|-----------------------|
| 15:1 | 30 - 90 bar | 10" (254 mm) | 70 cycles/min. |
| 6" (152 mm) | 68.6 l/min. @ 70 cycles/min | 3/4" NPT(F) | 980 cc |
| 2.1 - 6.2 bar | 0.98 cycle | 89.8 dBA @ 4.1 bar | 2" NPT(F) |
| 56.7 kg | 1 1/4" NPT(F) | | |

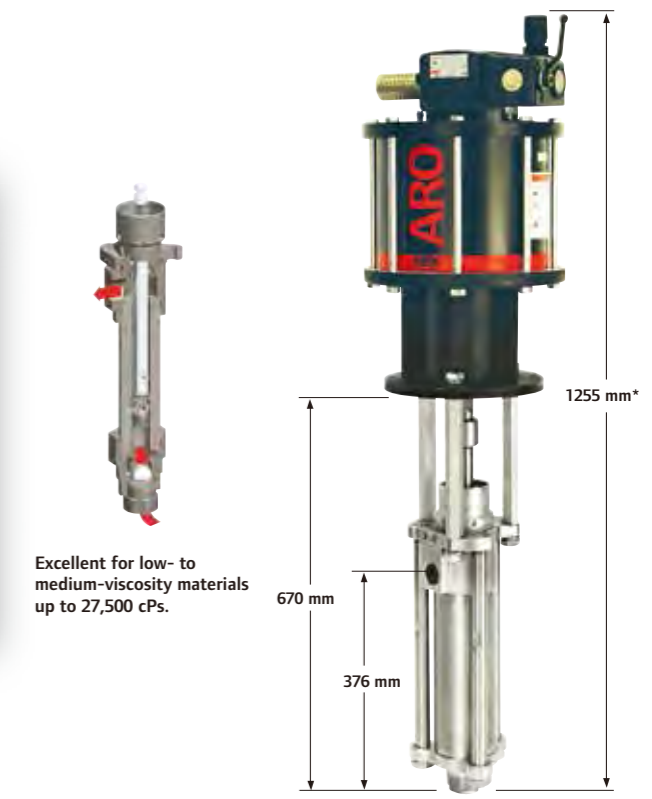
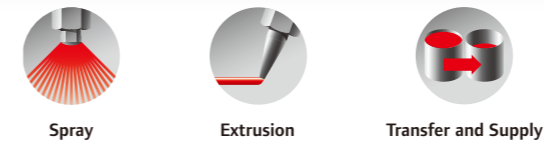





Excellent for low- to medium-viscosity materials up to 27,500 cPs.

Model shown w/ball valve regulator
*For models without ball valve regulator subtract 52.83mm

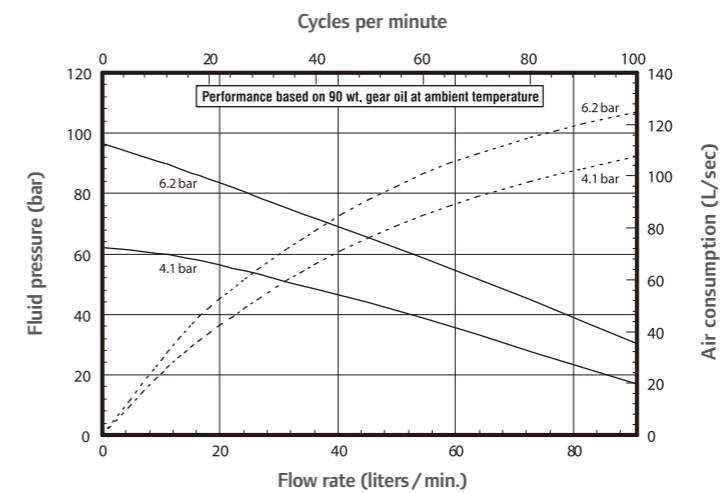
| Pump model no. (1) | Lower pump | Plunger material | Packings (upper + lower) | ServiceKit (2) | |
|----------------------|------------|--|------------------------------------|---|------------|
| AF1015C11FF35 | 66942-C6F | 300 / CF8M stainless steel | 321 stainless steel / hard chrome | UHMW-PE + UHMW-PE | 637211-C63 |
| AF1015C11GF35 | 66942-P6F | | | UHMW-PE / Mineral-filled PTFE + UHMW-PE | 637211-P63 |
| AF1015J11FF36 | 66941-CDD | 400 Series stainless steel with tungstene carbide seat | 15-5 stainless steel / hard chrome | UHMW-PE + UHMW-PE | 637211-C63 |
| AF1015F11FF36 | 66941-C6D | | | UHMW-PE + UHMW-PE | 637211-C63 |
| AF1015F11KK36 | 66941-L6D | 400 stainless steel | 15-5 stainless steel / hard chrome | Mineral-filled PTFE (upper & lower) | 637211-L63 |
| AF1015F11RK36 | 66941-R6D | | | Mineral-filled PTFE / UHMW-PE + Mineral-filled PTFE | 637211-R63 |

(1) Add "-1" to Model No. for Ball Valve Regulator
(2) Lower pump repair kit



| Pump accessories | |
|------------------|--|
| 67445-4 | High performance muffler  |
| 635043 | AroStop valve  |
| 67136 | Floor / follower plate adapter  |
| 637489 | Universal motor service kit |
| 67442 | Ball Valve Regulator |

22:1

7.3 l/min

AFX Series

2-ball piston pump

| Specifications | | | |
|----------------|--------------------|-----------------------|-----------------------------|
| ?:1 | 22:1 | Max. bar | 45 - 235 bar |
| Motor | 4 1/4" (108 mm) | Cycle/min. | 60 cycles/min. |
| Motor | 6" (152 mm) | 1 min. | 7.3 l/min. @ 60 cycles/min. |
| AIR | 1/2" NPT(F) | 1 cycle | 122.9 cc |
| Max. bar | 2 - 10.3 bar | For 1 litre | 8.1 cycles |
| Headphones | 86.5 dBA @ 4.1 bar | 1" NPT(F) / 2" NPT(M) | |
| Weight | 19.5 kg | 1" NPT(F) | |



Excellent for low- to medium-viscosity materials up to 7,500 cPs.

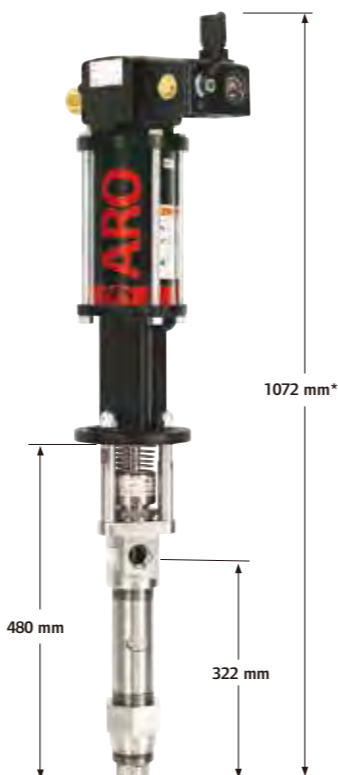

Model shown w/ball valve regulator
*For models without ball valve regulator subtract 52.83mm

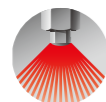

Spray



Extrusion



Transfer and Supply

| Pump model no. (1) | Lower pump | Plunger material | Packings (upper + lower) | ServiceKit (2) |
|--------------------|------------|--|---|---|
| AF0422G11FF47 | 66301-C43 | 300 Series stainless steel with tungstene carbide seat | UHMW-PE + UHMW-PE | 637306-C43 |
| AF0422G11KK47 | 66301-343 | | Glass-filled PTFE (upper & lower) | 637306-343 |
| AF0422G11HH47 | 66301-G43 | | UHMW-PE / Leather staggered (upper & lower) | 637306-G43 |
| AF0422G11GF47 | 66301-P43 | | UHMW-PE/glass-filled PTFE + UHMW-PE | 637306-P43 |
| AF0422G11RK47 | 66301-R43 | | Glass-filled PTFE/UHMW-PE + Glass-filled PTFE | 637306-R43 |
| AF0422G11RK48 | 66301-R48 | | 17-4 stainless steel with ceramic coating | Glass-filled PTFE/UHMW-PE + Glass-filled PTFE |

(1) Add "-1" to Model No. for Ball Valve Regulator

(2) Lower pump repair kit

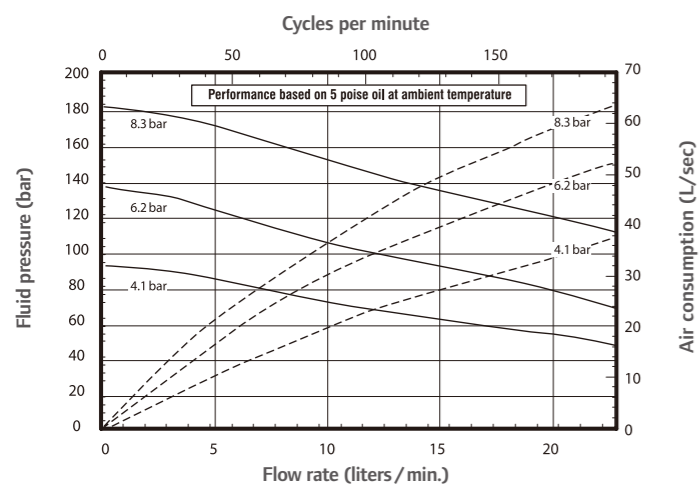

| Pump accessories | | |
|------------------|--------------------------------|--|
| 67445-1 | High performance muffler | |
| 23644-400 | AroStop valve | |
| 67136 | Floor / follower plate adapter | |
| 637489 | Universal motor service kit | |
| 67442 | Ball Valve Regulator | |

23:1

14.3 l/min

AFX Series

2-ball piston pump

| Specifications | | | |
|----------------|--------------------|-----------------------|------------------------------|
| ?:1 | 23:1 | Max. bar | 45 - 240 bar |
| Motor | 6" (152 mm) | Cycle/min. | 60 cycles/min. |
| Motor | 6" (152 mm) | 1 min. | 14.3 l/min. @ 60 cycles/min. |
| AIR | 1/2" NPT(F) | 1 cycle | 237.6 cc |
| Max. bar | 2.1 - 10.3 bar | For 1 litre | 4.2 cycles |
| Headphones | 84.7 dBA @ 4.1 bar | 1" NPT(F) / 2" NPT(M) | |
| Weight | 21 kg | 1" NPT(F) | |



Excellent for low- to medium-viscosity materials up to 7,500 cPs.



Model shown w/ball valve regulator
*For models without ball valve regulator subtract 52.83mm

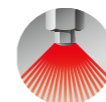

Spray



Extrusion





Transfer and Supply

| Pump model no. (1) | Lower pump | Plunger material | Packings (upper + lower) | ServiceKit (2) | |
|--------------------|------------|--|---|---|------------|
| AF0623G11FF47 | 66300-C43 | 300 Series stainless steel with tungstene carbide seat | UHMW-PE + UHMW-PE | 637305-C43 | |
| AF0623G11KK47 | 66300-343 | | Glass-filled PTFE (upper & lower) | 637305-343 | |
| AF0623G11KK48 | 66300-348 | | 17-4 stainless steel with ceramic coating | Glass-filled PTFE (upper & lower) | 637305-343 |
| AF0623G11HH47 | 66300-G43 | | 17-4 stainless steel / hard chrome | UHMW-PE / Leather staggered (upper & lower) | 637305-G43 |
| AF0623G11HH48 | 66300-G48 | | 17-4 stainless steel with ceramic coating | UHMW-PE / Leather staggered (upper & lower) | 637305-G43 |
| AF0623G11GF47 | 66300-P43 | | 17-4 stainless steel / hard chrome | UHMW-PE/glass-filled PTFE + UHMW-PE | 637305-P43 |
| AF0623G11RK48 | 66300-R48 | 17-4 stainless steel with ceramic coating | Glass-filled PTFE/UHMW-PE + Glass-filled PTFE | 637305-R43 | |
| AF0623G11RK47 | 66300-C43 | 17-4 stainless steel / hard chrome | Glass-filled PTFE/UHMW-PE + Glass-filled PTFE | 637305-R43 | |
| AF0623G11FF48 | 66300-C43 | 17-4 stainless steel with ceramic coating | UHMW-PE + UHMW-PE | 637305-C43 | |
| AF0623G11GF48 | 66300-P48 | | UHMW-PE/glass-filled PTFE + UHMW-PE | 637305-P43 | |

(1) Add "-1" to Model No. for Ball Valve Regulator

(2) Lower pump repair kit

| Pump accessories | |
|------------------|--|
| 67445-2 | High performance muffler  |
| 23644-400 | AroStop valve  |
| 67136 | Floor / follower plate adapter  |
| 637489 | Universal motor service kit |
| 67442 | Ball Valve Regulator |

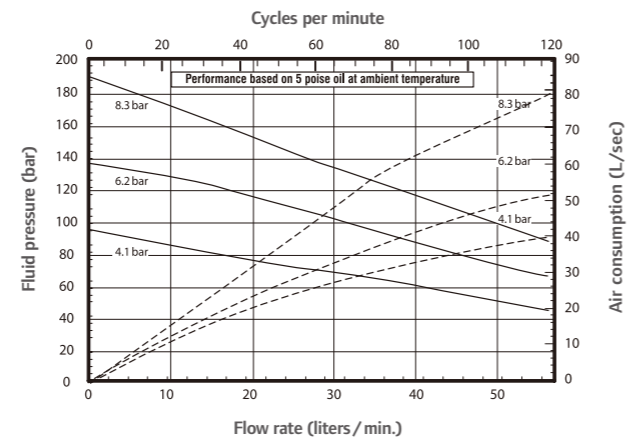

23:1 ratio pump package



66333-B
WetSol, pump upper packing lubricant - 1 liter

66334-B
WetSol, pump upper packing lubricant - 3.8 liters

66334-B

Recommended for use in piston pumps solvent cups – Increase the performance and service life of pumping equipment.



| Model | Type | Pump model | RAM model | Follower plate (model, seal and material) | Weight |
|------------------|----------------------|---------------|-----------|---|----------|
| TP0623G51RK47TA2 | 200 L / two-post RAM | AF0623G11RK47 | RM552S-C | 66516-6 Double lip / polyurethane Aluminum / PTFE coating | 179.5 kg |

| Pump package accessories | | | |
|--------------------------|----------------|-----------------------|-------------------------------|
| 66354-1 | 67481 | 67501 | 637472 |
| Pump stabilizing bracket | Cross over kit | Low-level cut-off kit | 200 L two-post RAM repair kit |

23:1

68.6 l/min

AFX Series

2-ball piston pump – UV/EB

| Specifications | | | |
|-------------------------|----------------------|-------------------------------|-------------------------------------|
| 23:1 | Max. bar | | 45 - 140 bar |
| Motor | 12" (305 mm) | Cycle/min. | 70 cycles/min. |
| Motor | 6" (152 mm) | 1 min. | 68.6 l/min. @ 60 cycles/min. |
| AIR | 3/4" NPT(F) | 1 cycle | 980 cc |
| Max. bar | 2.1 - 6.2 bar | For 1 litre | 1.02 cycle |
| 93 dBA @ 4.1 bar | | Follower plate mounted | |
| 90.7 kg | | 1 1/4" NPT(F) | |

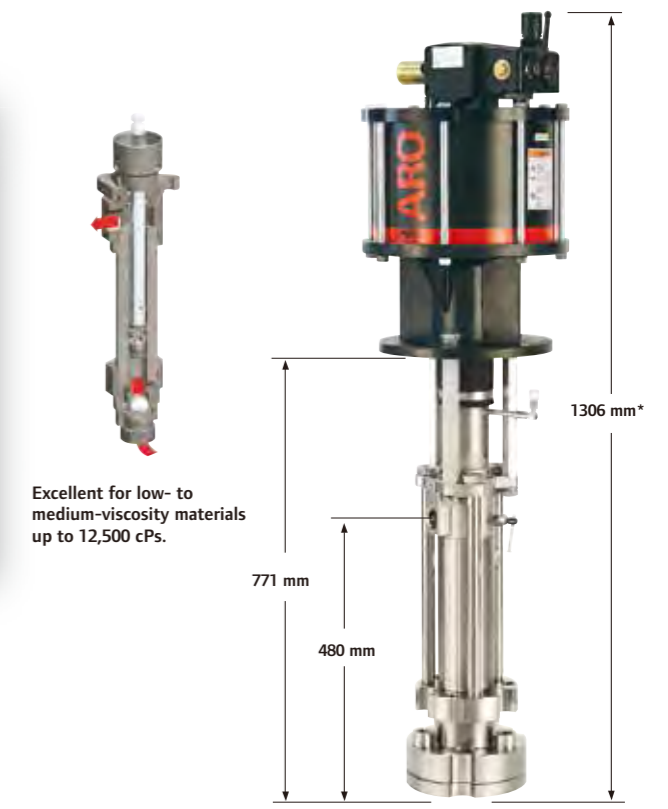



Excellent for low- to medium-viscosity materials up to 12,500 cPs.

Model shown w/ball valve regulator
*For models without ball valve regulator subtract 52.83mm

| Pump model no. (1) | Lower pump | Plunger material | Packings (upper + lower) | ServiceKit (2) |
|--------------------|------------|--|--------------------------|----------------|
| AF1223C51FF35 | 67372-C6F | 300 Series / CF8M stainless steel 321 stainless steel / hard chrome | UHMW-PE + UHMW-PE | 637444-C6D |
| AF1223C51FFP5 | 67372-CEF | | UHMW-PE + UHMW-PE | 637444-CED |

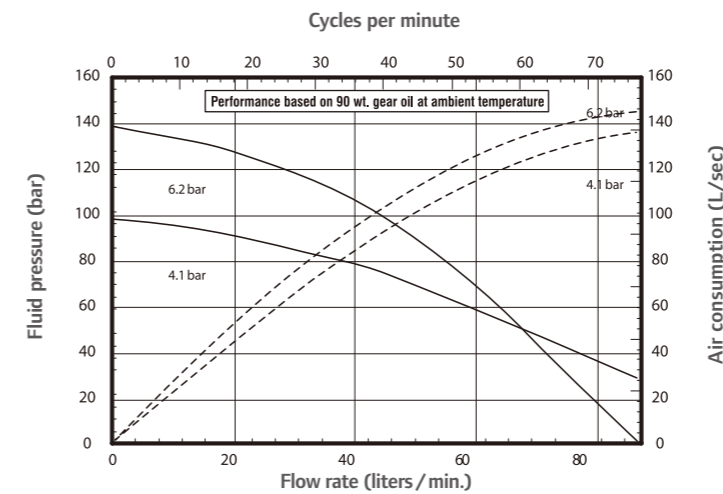
(1) Add "-1" to Model No. for Ball Valve Regulator
(2) Lower pump repair kit



| Pump accessories | |
|------------------|--|
| 67445-5 | High performance muffler  |
| 635043 | AroStop valve  |
| 637489 | Universal motor service kit |
| 67442 | Ball Valve Regulator |

23:1 ratio UV ink pump packages



| Model | Type | Pump model | RAM model | Follower plate (model, seal and material) | | | Weight |
|------------------|----------------------|---------------|-----------|---|---------------------------|-------------------------|----------|
| TP1223C51FF35TAC | 200 L / two-post RAM | AF1223C51FF35 | RM552S-C | 67409-6 | Double lip / polyurethane | Aluminum / PTFE coating | 233.4 kg |
| TP1223C51FFP5AN2 | | AF1223C51FFP5 | | 67410-2 | Double-tube, EPR | Aluminum | |



| Pump package accessories | | | | |
|--------------------------|-------------------------|--------------------|-----------------------|-------------------------------|
| 66353-1 | 104104-F06 | 67481 | 67501 | 637472 |
| Pump stabilizing bracket | Inline flow control (1) | Cross Over Kit (2) | Low level cut-off (3) | 200 L two-post RAM repair kit |

- (1) Helps set and maintain precise operating speeds in order to optimize pump performance.
- (2) Maintains fluid delivery in extrusion systems. Can activate alarm to alert maintenance to change empty fluid container.
- (3) Used to shut off air supply to pump when material container is empty or near-empty.

23:1

68.6 l/min

AFX Series

2-ball piston pump

| Specifications | | | |
|------------------|---------------|---------------|------------------------------|
| ?:1 | 23:1 | Max. bar | 45 - 140 bar |
| Motor | 12" (305 mm) | Cycle/min | 70 cycles/min. |
| Motor | 6" (152 mm) | 1 min. | 68.6 l/min. @ 70 cycles/min. |
| AIR | 3/4" NPT(F) | 1 cycle | 980 cc |
| Max. bar | 2.1 - 6.2 bar | For 1 litre | 1.02 cycle |
| 93 dBA @ 4.1 bar | | 2" NPT(F) | |
| 63.5 kg | | 1 1/4" NPT(F) | |

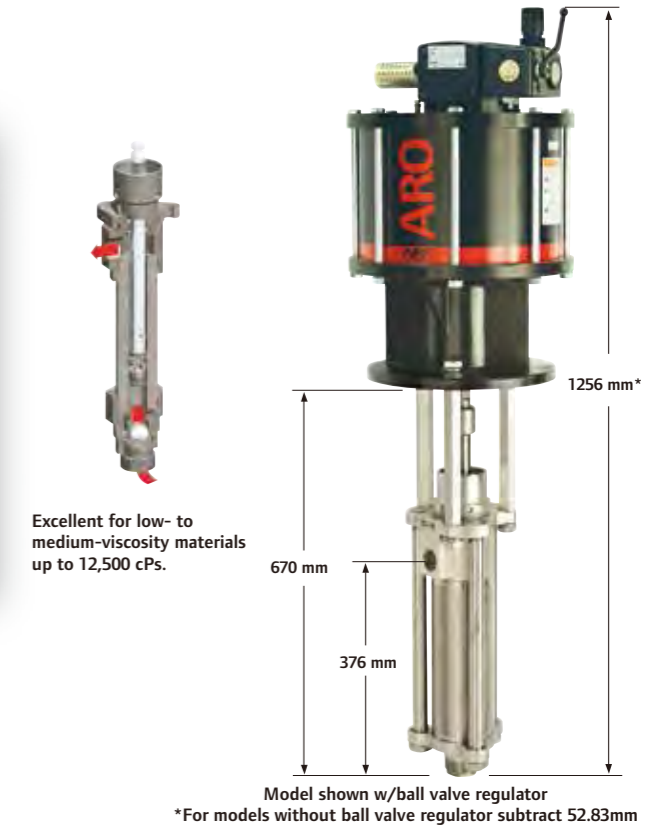
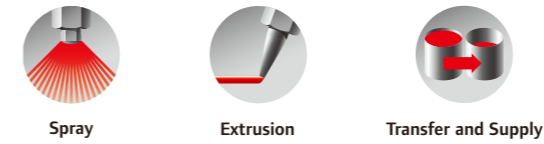

| Pump model no. (1) | Lower pump | Plunger materia | Packings (upper + lower) | ServiceKit (2) |
|--------------------|------------|-----------------------------------|---|----------------|
| AF1223C11CC15 | 66942-K3F | 300 Series / CF8M stainless steel | Carbon-Graphite Filled PTFE (upper & lower) | 637211-K33 |
| AF1223C11FF35 | 66942-C6F | | UHMW-PE + UHMW-PE | 637211-C63 |
| AF1223F11GF36 | 66941-P6D | 400 Series stainless steel | UHMW-PE / mineral-filled PTFE + UHMW-PE | 637211-P63 |
| AF1223F11FF36 | 66941-C6D | | UHMW-PE + UHMW-PE | 637211-C63 |

- (1) Add "-1" to Model No. for Ball Valve Regulator
- (2) Lower pump repair kit

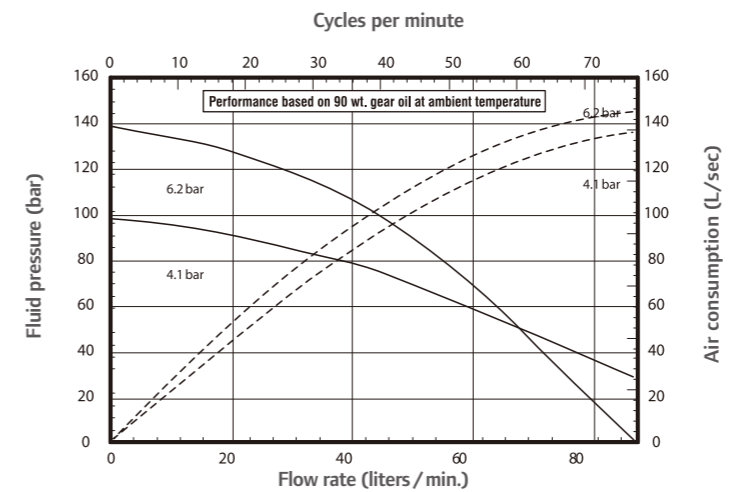

| Pump accessories | |
|------------------|--------------------------------|
| 67445-5 | High performance muffler |
| 635043 | AroStop valve |
| 67136 | Floor / follower plate adapter |
| 637489 | Universal motor service kit |
| 67442 | Ball Valve Regulator |

28:1

23.7 l/min

AFX Series

2-ball piston pump

| Specifications | | | |
|-------------------|--------------------|-------------|------------------------------|
| ?:1 | 28:1 | Max. bar | 60 - 230 bar |
| Motor | 8" (203 mm) | Cycle/min. | 70 cycles/min. |
| Motor | 6" (152 mm) | 1 min. | 23.7 l/min. @ 70 cycles/min. |
| AIR | 3/4" NPT(F) | 1 cycle | 338 cc |
| Max. bar | 2.1 - 8.3 bar | For 1 litre | 2.95 cycles |
| Headphones | 86.8 dBA @ 4.1 bar | | 2" NPT(F) |
| Weight | 51.3 kg | | 1" NPT(F) |



Excellent for low- to medium-viscosity materials up to 75,000 cPs.

Model shown w/ball valve regulator
*For models without ball valve regulator subtract 52.83mm

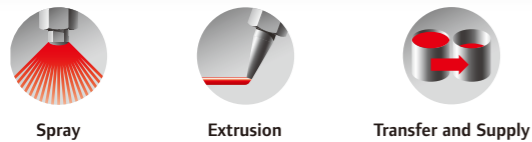

30:1

4.9 l/min

AFX Series

2-ball piston pump

| Specifications | | | |
|-------------------|--------------------|-------------|-----------------------------|
| ?:1 | 30:1 | Max. bar | 60 - 320 bar |
| Motor | 4 1/4" (108 mm) | Cycle/min. | 60 cycles/min. |
| Motor | 6" (152 mm) | 1 min. | 4.9 l/min. @ 60 cycles/min. |
| AIR | 1/2" NPT(F) | 1 cycle | 90.1 cc |
| Max. bar | 2 - 10.3 bar | For 1 litre | 11 cycles |
| Headphones | 86.5 dBA @ 4.1 bar | | 1" NPT(F) / 2" NPT(M) |
| Weight | 19.5 kg | | 1 NPT(F) |

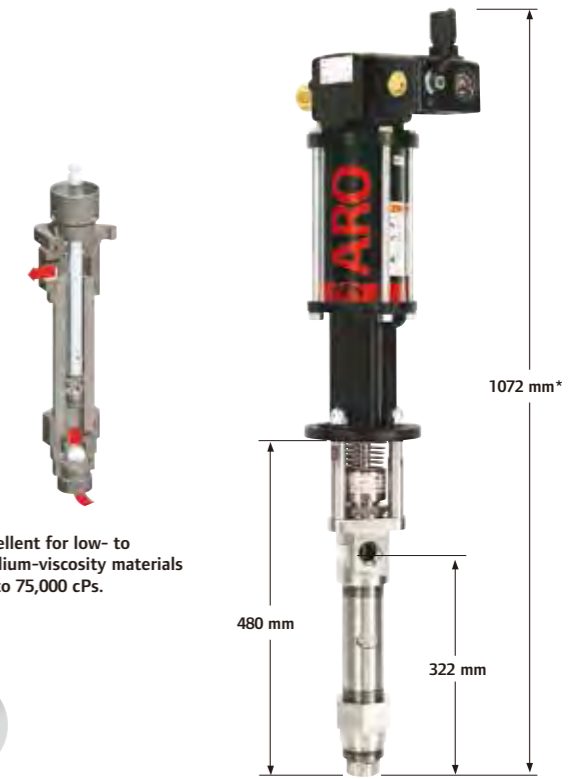

Excellent for low- to medium-viscosity materials up to 75,000 cPs.

Model shown w/ball valve regulator
*For models without ball valve regulator subtract 52.83mm

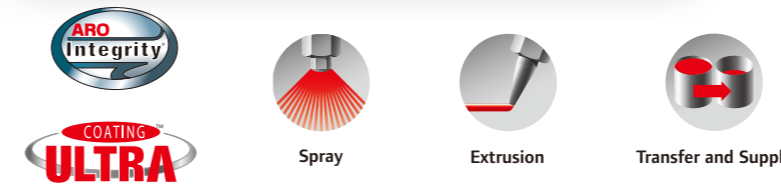

| Pump model no. (1) | Lower pump | Plunger material | Packings (upper + lower) | ServiceKit (2) | |
|--------------------|------------|-----------------------------|------------------------------------|---|------------|
| AF0828B11RK47 | 66475-R4D | Carbon steel, nickel plated | 17-4 stainless steel / hard chrome | Glass-filled PTFE/UHMW-PE + Glass-filled PTFE | 667098-R43 |

(1) Add "-1" to Model No. for Ball Valve Regulator
(2) Lower pump repair kit

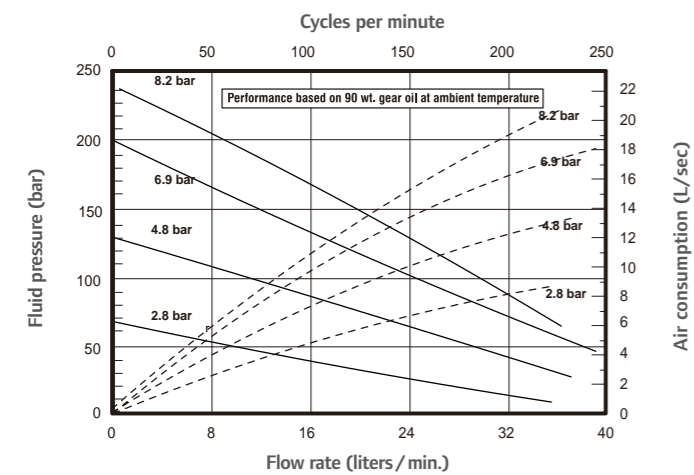

| Pump accessories | |
|------------------|-----------------------------|
| 67445-3 | High performance muffler |
| 635043 | AroStop valve |
| 65139 | Floor mount |
| 637489 | Universal motor service kit |
| 67442 | Ball Valve Regulator |



66333-B
WetSol, pump upper packing lubricant - 1 liter



66334-B
WetSol, pump upper packing lubricant - 3.8 liters

66334-B

| Pump model no. (1) | Lower pump | Plunger material | Packings (upper + lower) | ServiceKit (2) |
|--------------------|------------|--|---|-------------------------------------|
| AF0430G11FF47 | 66302-C43 | 300 Series stainless steel with tungstene carbide seat | UHMW-PE + UHMW-PE | 637307-C43 |
| AF0430G11KK47 | 66302-343 | | Glass-filled PTFE (upper & lower) | 637307-343 |
| AF0430G11HH47 | 66302-G43 | | UHMW-PE / Leather staggered (upper & lower) | 637307-G43 |
| AF0430G11GF47 | 66302-P43 | | UHMW-PE/glass-filled PTFE + UHMW-PE | 637307-P43 |
| AF0430G11GF48 | 66302-P4B | | 17-4 stainless steel with ceramic coating | UHMW-PE/glass-filled PTFE + UHMW-PE |
| AF0430G11HH48 | 66302-G4B | UHMW-PE / Leather staggered (upper & lower) | | 637307-G43 |

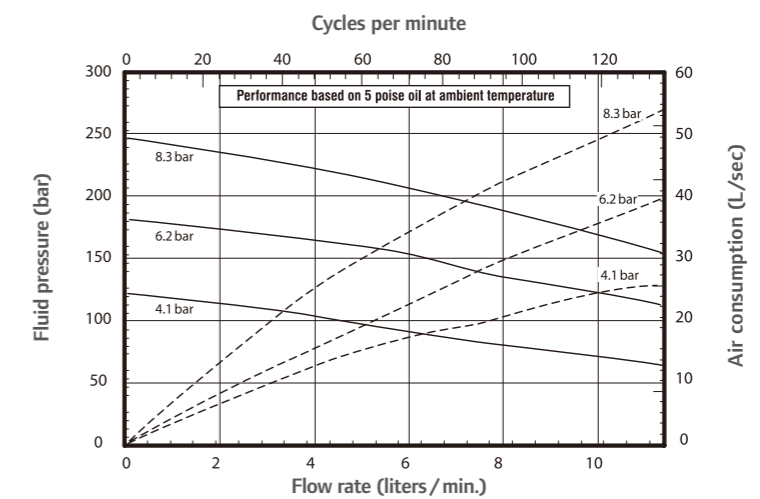
(1) Add "-1" to Model No. for Ball Valve Regulator
(2) Lower pump repair kit



| Pump accessories | |
|------------------|--|
| 67445-1 | High performance muffler  |
| 23644-400 | AroStop valve  |
| 67136 | Floor / follower plate adapter  |
| 637489 | Universal motor service kit |
| 67442 | Ball Valve Regulator |



66333-B
WetSol, pump upper packing lubricant - 1 liter

66334-B
WetSol, pump upper packing lubricant - 3.8 liters

66334-B

Recommended for use in piston pumps solvent cups – Increase the performance and service life of pumping equipment.

30:1 ratio pump package



20 L 

| Model | Type | Pump model | Cart model | Material hose | Material filter | Weight |
|------------------|-------------------|-----------------|------------|---------------|-----------------|---------|
| CM0430G11GF47001 | Cart-mounted pump | AF0430G11GF47-1 | 67139 | 67140-1 | 651422-70 | 52.1 kg |















| Pump package accessories | |
|--------------------------|----------------|
| F35341-400 | 104317 |
| Air filter | Filter element |



40:1

AFX Series

2-ball piston pump

| Specifications | | | |
|---|--------------------|---|----------------------------|
|  | 40:1 |  | 80 - 340 bar |
|  | 8" (203 mm) |  | 70 cycles/min. |
|  | 6" (152 mm) |  | 14 l/min. @ 60 cycles/min. |
|  | 3/4" NPT(F) |  | 237 cc |
|  | 2.1 - 8.3 bar |  | 4.2 cycles |
|  | 86.8 dBA @ 4.1 bar |  | 1" NPT(F) / 2" NPT(M) |
|  | 30.9 kg |  | 1 NPT(F) |

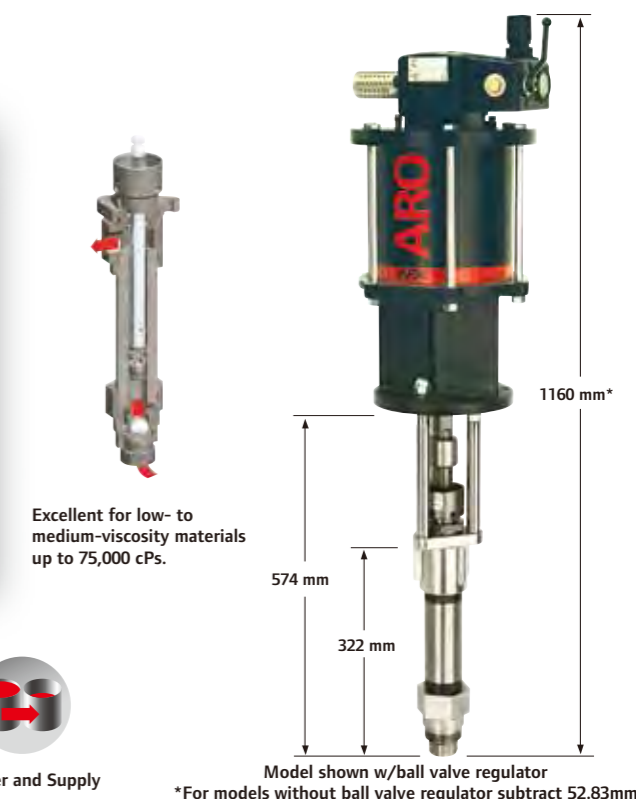





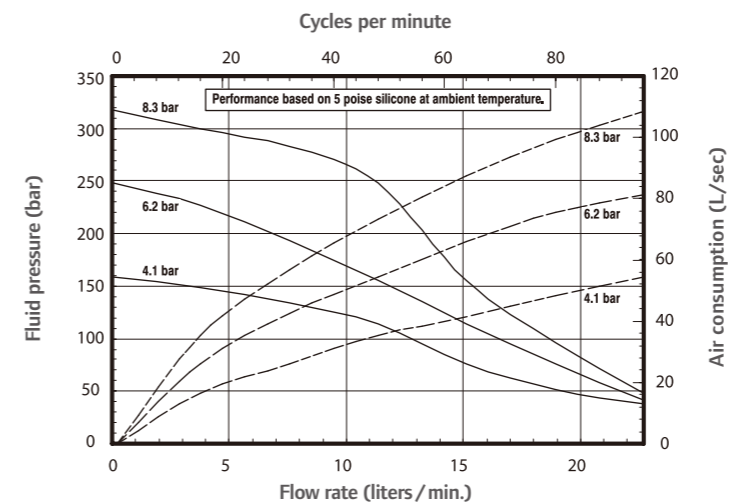

 Spray
  Extrusion
  Transfer and Supply

| Pump model no. (1) | Lower pump | Plunger material | Packings (upper + lower) | ServiceKit (2) |
|--------------------|------------|--|---|----------------|
| AF0840G11FF47 | 66300-C4D | 300 Series stainless steel with tungstene carbide seat | UHMW-PE + UHMW-PE | 637305-C43 |
| AF0840G11KK47 | 66300-34D | | Glass-filled PTFE (upper & lower) | 637305-343 |
| AF0840G11GF47 | 66300-P4D | | UHMW-PE/glass-filled PTFE + UHMW-PE | 637305-P43 |
| AF0840G11RS47 | 66300-R43 | | Glass-filled PTFE / UHMW-PE + Virgin PTFE | 637305-R43 |
| AF0840G11FF48 | 66300-C4G | 17-4 stainless steel with ceramic coating | UHMW-PE + UHMW-PE | 637305-C43 |
| AF0840G11RS48 | 66300-R4G | | Glass-filled PTFE / UHMW-PE + Virgin PTFE | 637305-R43 |

(1) Add "-1" to Model No. for Ball Valve Regulator
(2) Lower pump repair kit



| Pump accessories | |
|------------------|--|
| 67445-3 | High performance muffler  |
| 635043 | AroStop valve  |
| 67136 | Floor / follower plate adapter  |
| 637489 | Universal motor service kit |
| 67442 | Ball Valve Regulator |

45:1

23.7 l/min

AFX Series

2-ball piston pump

| Specifications | | | |
|--------------------|---------------|-------------|------------------------------|
| ?:1 | 45:1 | Max. bar | 95 -280 bar |
| Motor | 10" (254 mm) | Cycle/min. | 70 cycles/min. |
| Motor | 6" (152 mm) | 1 min. | 23.7 l/min. @ 70 cycles/min. |
| AIR | 3/4" NPT(F) | 1 cycle | 339 cc |
| Max. bar | 2.1 - 6.2 bar | For 1 litre | 2.9 cycles |
| 89.8 dBA @ 4.1 bar | | 2" NPT(F) | |
| 59.9 kg | | 1 NPT(F) | |

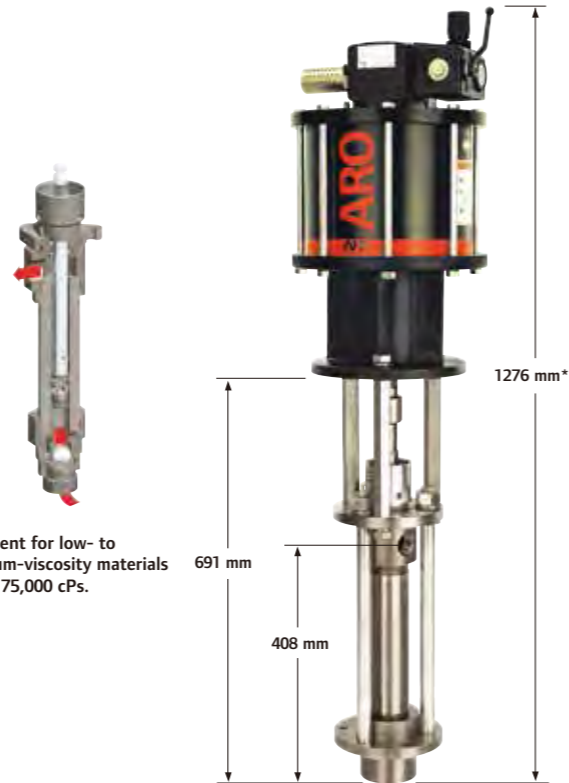

Excellent for low- to medium-viscosity materials up to 75,000 cPs.

Model shown w/ball valve regulator
*For models without ball valve regulator subtract 52.83mm



45:1

7.3 l/min

AFX Series

2-ball piston pump

| Specifications | | | |
|--------------------|-------------|-----------------------|-----------------------------|
| ?:1 | 45:1 | Max. bar | 95 - 375 bar |
| Motor | 6" (152 mm) | Cycle/min. | 60 cycles/min. |
| Motor | 6" (152 mm) | 1 min. | 7.3 l/min. @ 60 cycles/min. |
| AIR | 1/2" NPT(F) | 1 cycle | 123 cc |
| Max. bar | 2 - 8.3 bar | For 1 litre | 8.1 cycles |
| 84.7 dBA @ 4.1 bar | | 1" NPT(F) / 2" NPT(M) | |
| 21 kg | | 1 NPT(F) | |

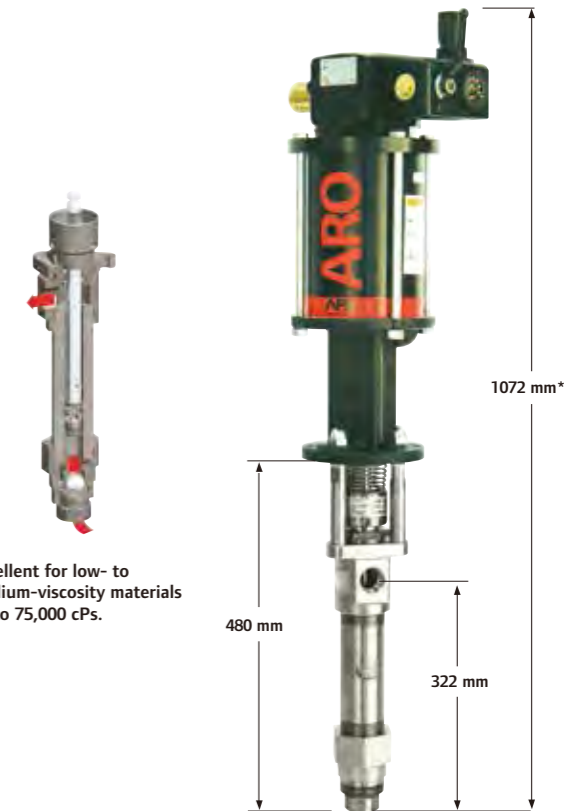

Excellent for low- to medium-viscosity materials up to 75,000 cPs.

Model shown w/ball valve regulator
*For models without ball valve regulator subtract 52.83mm



| Pump model no. (1) | Lower pump | Plunger material | Packings (upper + lower) | ServiceKit (2) | |
|--------------------|------------|-----------------------------|------------------------------------|---|------------|
| AF1045B11KK47 | 66475-34D | Carbon steel, nickel plated | 17-4 stainless steel / hard chrome | Glass-filled PTFE (upper & lower) | 637098-343 |
| AF1045B11RK47 | 66475-R4D | | | Glass-filled PTFE/UHMW-PE + Glass-filled PTFE | 637098-R43 |

(1) Add "-1" to Model No. for Ball Valve Regulator
(2) Lower pump repair kit

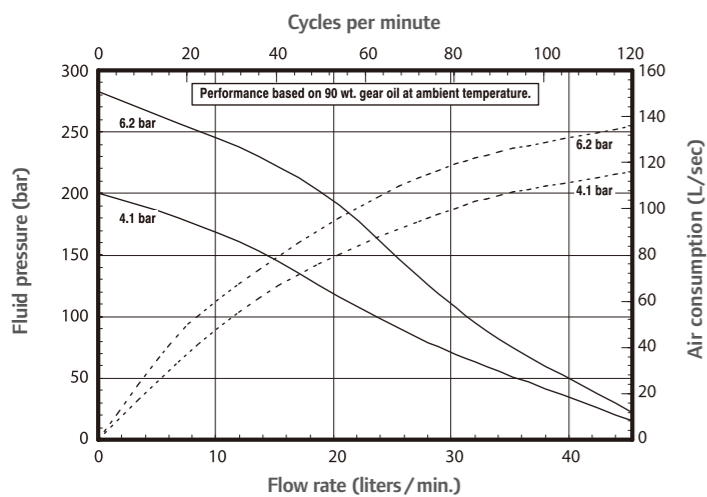

| Pump accessories | |
|------------------|-----------------------------|
| 67445-4 | High performance muffler |
| 635043 | AroStop valve |
| 65139 | Floor mount |
| 637489 | Universal motor service kit |
| 67442 | Ball Valve Regulator |

| Pump model no. (1) | Lower pump | Plunger material | Packings (upper + lower) | ServiceKit (2) | |
|--------------------|------------|--|---|-------------------|------------|
| AF0645G11FF47 | 66301-C43 | 300 Series stainless steel with tungstene carbide seat | 17-4 stainless steel / hard chrome | UHMW-PE + UHMW-PE | 637306-C43 |
| AF0645G11KK47 | 66301-343 | | Glass-filled PTFE (upper & lower) | 637306-343 | |
| AF0645G11HH47 | 66301-G43 | | UHMW-PE / Leather staggered (upper & lower) | 637306-G43 | |
| AF0645G11GF47 | 66301-P43 | | UHMW-PE/glass-filled PTFE + UHMW-PE | 637306-P43 | |
| AF0645G11RK47 | 66301-R43 | | Glass-filled PTFE/UHMW-PE + Glass-filled PTFE | 637306-R43 | |
| AF0645G11FF48 | 66301-C4B | | 17-4 stainless steel with ceramic coating | UHMW-PE + UHMW-PE | 637306-C43 |
| AF0645G11RK48 | 66301-R4B | Glass-filled PTFE/UHMW-PE + Glass-filled PTFE | 637306-R43 | | |

(1) Add "-1" to Model No. for Ball Valve Regulator
(2) Lower pump repair kit

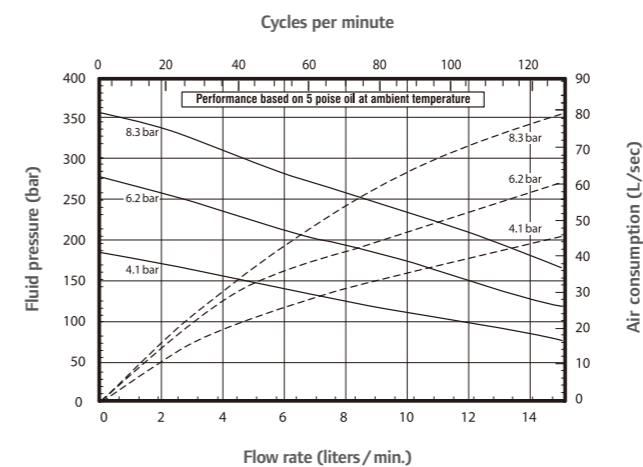

| Pump accessories | |
|------------------|--------------------------------|
| 67445-2 | High performance muffler |
| 23644-400 | AroStop valve |
| 67136 | Floor / follower plate adapter |
| 637489 | Universal motor service kit |
| 67442 | Ball Valve Regulator |

45:1 ratio pump packages

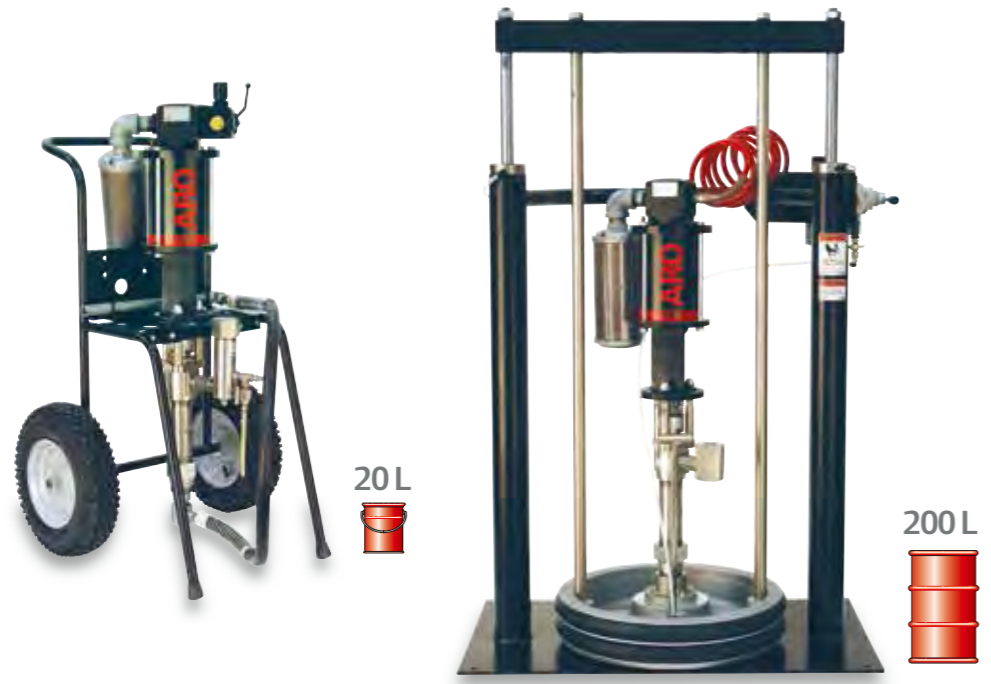

| Model | Pump | Cart | RAM | Material hose & filter | Follower plate (model, seal and material) | Weight |
|----------------------------|-----------------|-------|----------|------------------------|---|----------|
| Cart-mounted pump | | | | | | |
| CM0645G11GF47001 | AF0645G11GF47-1 | 67139 | — | 67140-1 & 651422-70 | — | 53.5 kg |
| 200 L, two-post RAM | | | | | | |
| TP0645G51RK47TN2 | AF0645G11RK47 | — | RM552S-C | — | 67195-6 Double-tube / EPR Aluminum / PTFE coating | 180.4 kg |
| TP0645G51RK47TB2 | | | | | 66516-7 Double lip / EPR Aluminum / PTFE coating | |

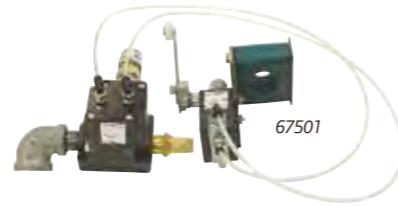
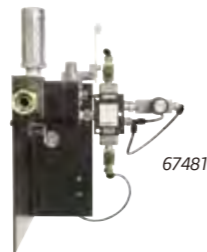

| Pump package accessories | | | |
|--------------------------|----------------|-----------------------|-------------------------------|
| 66354-1 | 67481 | 67501 | 637472 |
| Pump stabilizing bracket | Cross over kit | Low-level cut-off kit | 200 L two-post RAM repair kit |

60:1
5.4 l/min

AFX Series

2-ball piston pump

| Specifications | | | |
|----------------|--------------------|----------------|-----------------------------|
| Ratio | 60:1 | Max. bar | 125 - 425 bar |
| Motor | 6" (152 mm) | Cycle/min | 60 cycles/min. |
| Motor | 6" (152 mm) | 1 min. / Cycle | 5.4 l/min. @ 60 cycles/min. |
| AIR | 1/2" NPT(F) | For 1 litre | 90.1 cc |
| Max. bar | 2 - 6.9 bar | For 1 litre | 11 cycles |
| Headphones | 84.7 dBA @ 4.1 bar | Flow | 1" NPT(F) / 2" NPT(M) |
| Weight | 21 kg | Flow | 1 NPT(F) |

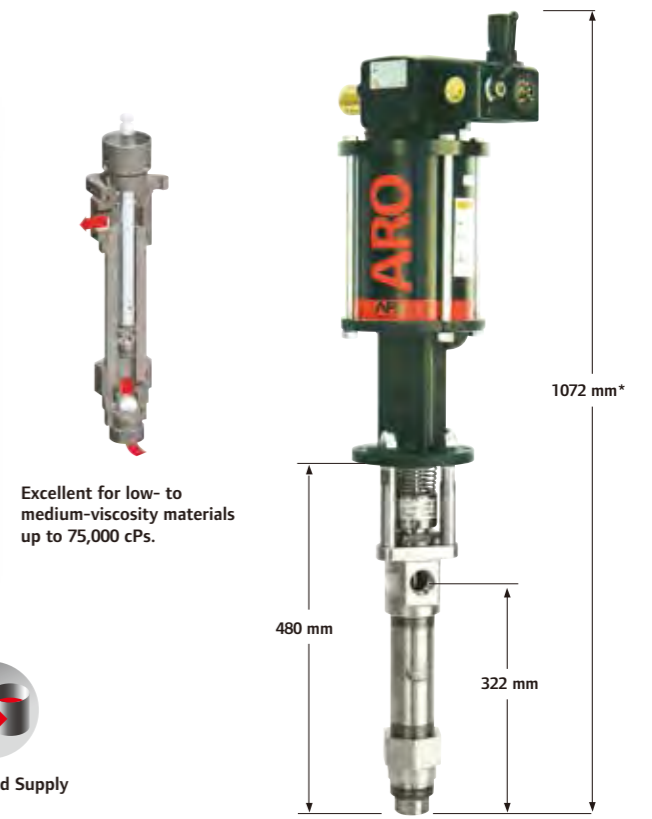





Excellent for low- to medium-viscosity materials up to 75,000 cPs.

Model shown w/ball valve regulator
*For models without ball valve regulator subtract 52.83mm

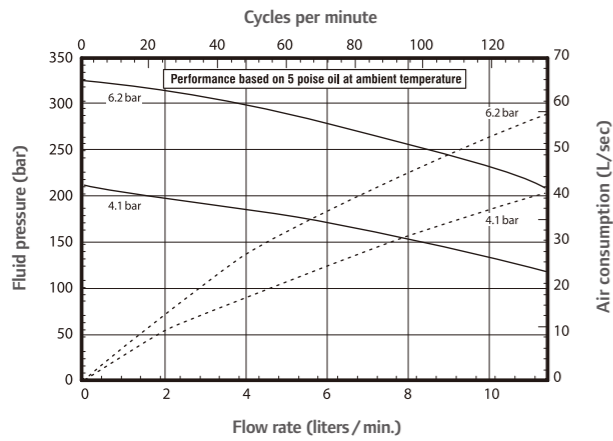
| Pump model no. (1) | Lower pump | Plunger material | Packings (upper + lower) | ServiceKit (2) |
|--------------------|------------|--|---|----------------|
| AF0660G11FF47 | 66302-C43 | 300 Series stainless steel with tungstene carbide seat | UHMW-PE + UHMW-PE | 637307-C43 |
| AF0660G11KK47 | 66302-343 | | Glass-filled PTFE (upper & lower) | 637307-343 |
| AF0660G11HH47 | 66302-G43 | | UHMW-PE / Leather staggered (upper & lower) | 637307-G43 |
| AF0660G11RK47 | 66302-R43 | | Glass-filled PTFE/UHMW-PE + Glass-filled PTFE | 637307-R43 |
| AF0660G11GF47 | 66302-P43 | | UHMW-PE/glass-filled PTFE + UHMW-PE | 637307-P43 |
| AF0660G11FF48 | 66302-C4B | 17-4 stainless steel with ceramic coating | UHMW-PE + UHMW-PE | 637307-C43 |

(1) Add "-1" to Model No. for Ball Valve Regulator
(2) Lower pump repair kit

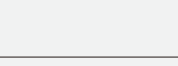
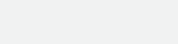

| Pump accessories | |
|------------------|--|
| 67445-2 | High performance muffler  |
| 23644-400 | AroStop valve  |
| 67136 | Floor / follower plate adapter  |
| 637489 | Universal motor service kit  |
| 67442 | Ball Valve Regulator  |

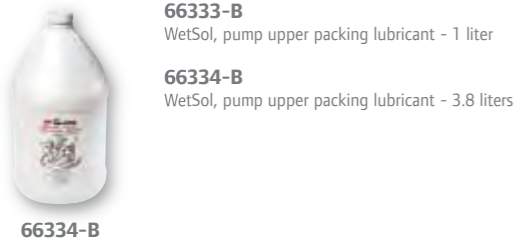

Recommended for use in piston pumps solvent cups – Increase the performance and service life of pumping equipment.

60:1 ratio pump package

















| Model | Type | Pump model | Cart model | Material hose | Material filter | Regulator | Weight |
|------------------|-------------------|-----------------|------------|---------------|-----------------|-----------|---------|
| CM0660G11GF47001 | Cart-mounted pump | AF0660G11GF47-1 | 67139 | 67140-1 | 651422-70 | 67442 | 55.7 kg |

| Pump package accessories | |
|--------------------------|----------------|
| F35341-400 | 104317 |
| Air filter | Filter element |



65:1
23.7 l/min
AFX Series
2-ball piston pump



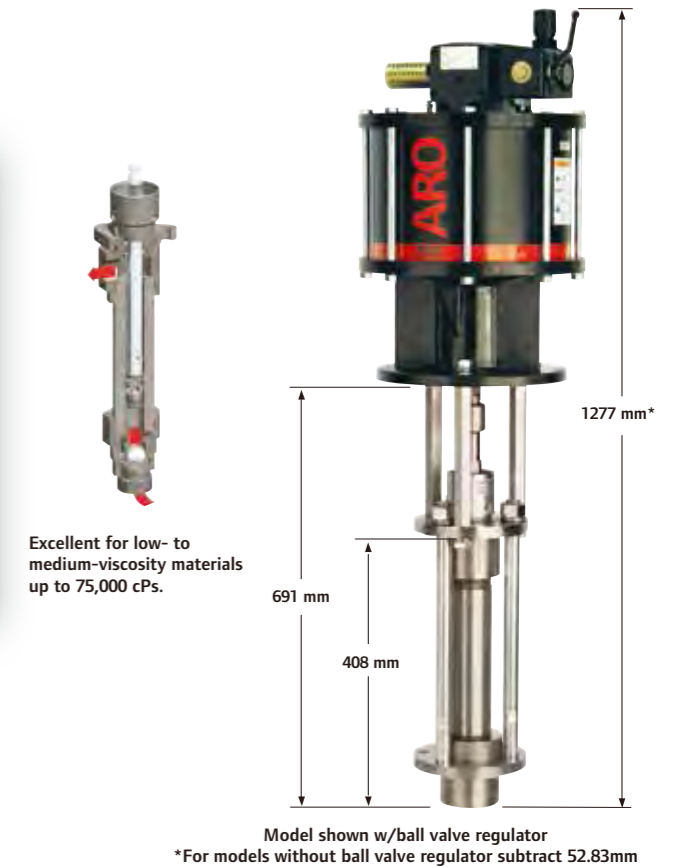
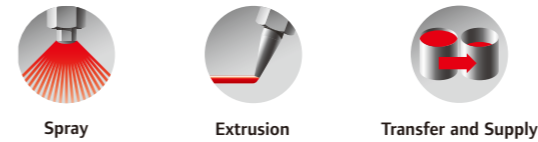

| Specifications | | | |
|---|------------------|---|------------------------------|
|  | 65:1 |  | 135 - 400 bar |
|  | 12" (305 mm) |  | 70 cycles/min. |
|  | 6" (152 mm) |  | 23.7 l/min. @ 70 cycles/min. |
|  | 3/4" NPT(F) |  | 339 cc |
|  | 2.1 - 6.2 bar |  | 2.9 cycles |
|  | 93 dBA @ 4.1 bar |  | 2" NPT(F) |
|  | 66.7 kg |  | 1 NPT(F) |

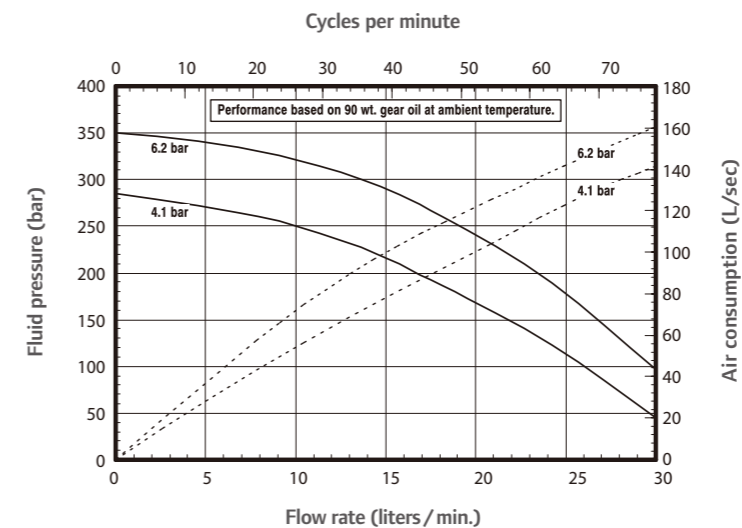

| Pump model no. (1) | Lower pump | Plungter material | Packings (upper + lower) | ServiceKit (2) |
|--------------------|------------|-----------------------------|---|----------------|
| AF1265B11HH47 | 66475-G4D | Carbon steel, nickel plated | UHMW-PE / Leather staggered (upper & lower) | 637098-G43 |
| AF1265B11FF47 | 66475-C4D | | UHMW-PE + UHMW-PE | 637098-C43 |
| AF1265B11RK47 | 66475-R4D | | Glass-filled PTFE/UHMW-PE + Glass-filled PTFE | 637098-R43 |

(1) Add "-1" to Model No. for Ball Valve Regulator
(2) Lower pump repair kit

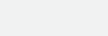

| Pump accessories | |
|------------------|---|
| 67445-5 | High performance muffler  |
| 635043 | AroStop valve  |
| 65139 | Floor mount  |
| 637489 | Universal motor service kit  |
| 67442 | Ball Valve Regulator  |

65:1 ratio pump package

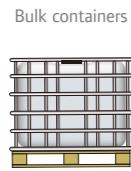

| Model | Type | Pump model | Cart model | Material hose | Material filter | Material | Weight |
|------------------|-------------------|-----------------|------------|---------------|-----------------|-------------------------|---------|
| CM1265B11HH47001 | Cart-mounted pump | AF1265B11HH47-1 | 66554-2 | 66728 | 651481-70-B | Aluminum / PTFE coating | 97.4 kg |

| Pump package accessories | |
|--------------------------|----------------|
| F35341-400 | 104317 |
| Air filter | Filter element |



F35341-400



66334-B

66333-B
WetSol, pump upper packing lubricant - 1 liter
66334-B
WetSol, pump upper packing lubricant - 3.8 liters

Recommended for use in piston pumps solvent cups – Increase the performance and service life of pumping equipment.

2:1
80.6 l/min

AFX Series

4-ball piston pump

| Specifications | | | |
|----------------|--------------------|---------------------------|-----------------------------|
| ? | 2:1 | Max. bar | 4 - 21 bar |
| Motor | 4 1/4" (108 mm) | Cycle/min. | 60 cycles/min. |
| Motor | 6" (152 mm) | 1 min. | 80.6 l/min. @60 cycles/min. |
| AIR | 1/2" NPT(F) | 1 cycle | 1345 cc |
| Max. bar | 2.1 - 10.3 bar | For 1litre | 0.74 cycle |
| Headphones | 86.5 dBA @ 4.1 bar | 1 1/2" NPT(F) / 2" NPT(M) | |
| Weight | 30.8 kg | 1 NPT(F) | |



Transfer and Supply



Designed for high volume transfer of low-and medium-viscosity fluids up to 12,500 cPs.



Model shown w/ball valve regulator

*For models without ball valve regulator subtract 52.83mm

| Pump model no. (1) | Lower pump | Plunger material | Packings (upper + lower) | ServiceKit (2) | |
|--------------------|------------|-----------------------------------|---|---------------------------------------|------------|
| AF0402M11HF48 | 67200-F4B | 300 Series / CF8M stainless steel | 17-4 stainless steel with ceramic coating | UHMW-PE / Leather staggered + UHMW-PE | 637317-F4B |
| AF0402M11RS48 | 67200-R4B | | Glass-filled PTFE / UHMW-PE staggered + Virgin PTFE | 637317-R4B | |
| AF0402M11KS48 | 67200-74B | | Glass-filled PTFE + Virgin PTFE | 637317-74B | |
| AF0402M11FF48 | 67200-C4B | | UHMW-PE + UHMW-PE | 637317-C4B | |

(1) Add "-1" to Model No. for Ball Valve Regulator

(2) Lower pump repair kit

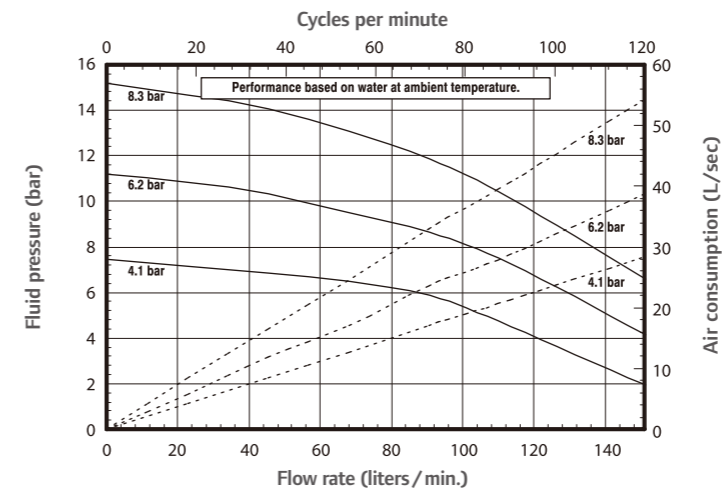

| Pump accessories | |
|------------------|-----------------------------|
| 67445-1 | High performance muffler |
| 23644-400 | AroStop valve |
| 67187-1 | Mounting post |
| 637489 | Universal motor service kit |
| 67442 | Ball Valve Regulator |

3:1
110.8 l/min

AFX Series

4-ball piston pump

| Specifications | | | |
|---------------------------|----------------|----------------------------------|------------------------------|
| ?:1 | 3:1 | Max. bar | 6 - 31 bar |
| Motor | 6" (152 mm) | Cycle/min. | 60 cycles/min. |
| Motor | 6" (152 mm) | 1 min. | 110.8 l/min. @60 cycles/min. |
| AIR | 1/2" NPT(F) | 1 cycle | 1847 cc |
| Max. bar | 2.1 - 10.3 bar | For 1litre | 0.54 cycle |
| 84.7 dBA @ 4.1 bar | | 1 1/2" NPT(F) / 2" NPT(M) | |
| 33.2 kg | | 1 NPT(F) | |

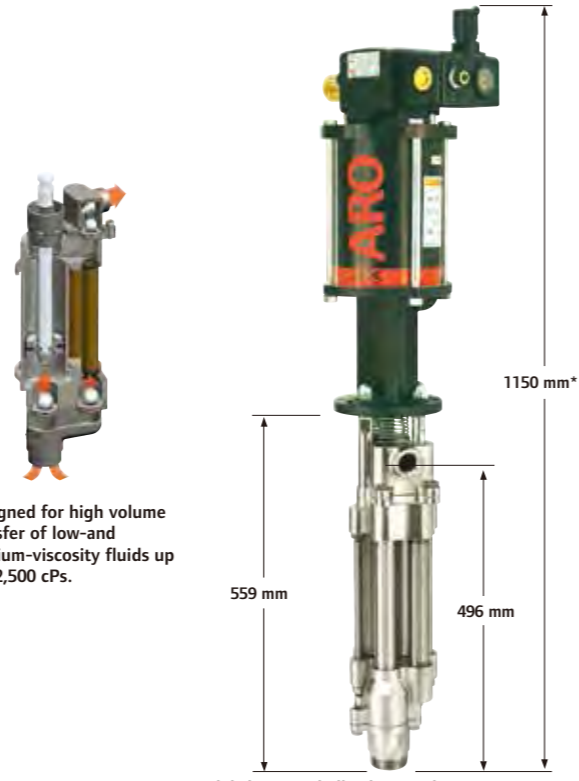

Designed for high volume transfer of low-and medium-viscosity fluids up to 12,500 cPs.

Model shown w/ball valve regulator
*For models without ball valve regulator subtract 52.83mm



Transfer and Supply

| Pump model no. (1) | Lower pump | Plunger material | Packings (upper + lower) | ServiceKit (2) |
|--------------------|------------|-----------------------------------|---|----------------|
| AF0603M11FF48 | 67201-C4B | 300 Series / CF8M stainless steel | UHMW-PE + UHMW-PE | 637318-C4B |
| AF0603M11KS48 | 67201-74B | | Glass-filled PTFE + Virgin PTFE | 637318-74B |
| AF0603M11HF48 | 67201-F4B | | UHMW-PE / Leather staggered + UHMW-PE | 637318-F4B |
| AF0603M11RS48 | 67201-R4B | | Glass-filled PTFE / UHMW-PE staggered + Virgin PTFE | 637318-R4B |
| AF0603M11GF48 | 67201-P4B | | UHMW-PE/glass-filled PTFE + UHMW-PE | 637318-P4B |
| | | | 17-4 stainless steel with ceramic coating | |

(1) Add "-1" to Model No. for Ball Valve Regulator
(2) Lower pump repair kit

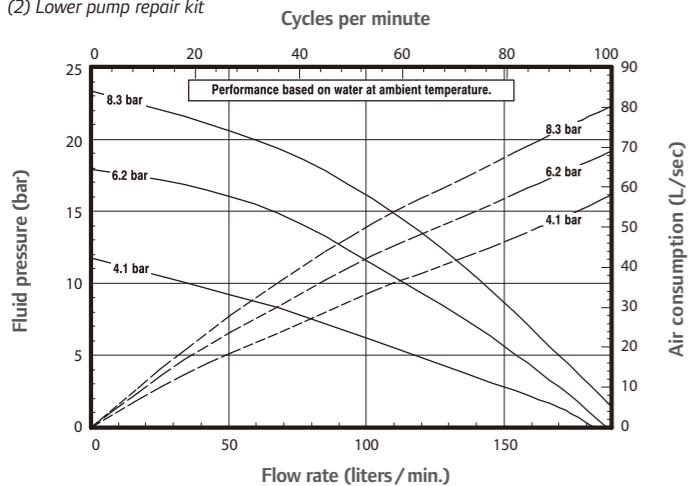

| Pump accessories | |
|------------------|-----------------------------|
| 67445-2 | High performance muffler |
| 23644-400 | AroStop valve |
| 67187-1 | Mounting post |
| 637489 | Universal motor service kit |
| 67442 | Ball Valve Regulator |

4:1
80.6 l/min

AFX Series

4-ball piston pump

| Specifications | | | |
|---------------------------|----------------|----------------------------------|-----------------------------|
| ?:1 | 4:1 | Max. bar | 8 - 45 bar |
| Motor | 6" (152 mm) | Cycle/min. | 60 cycles/min. |
| Motor | 6" (152 mm) | 1 min. | 80.6 l/min. @60 cycles/min. |
| AIR | 1/2" NPT(F) | 1 cycle | 1345 cc |
| Max. bar | 2.1 - 10.3 bar | For 1litre | 0.74 cycle |
| 84.7 dBA @ 4.1 bar | | 1 1/2" NPT(F) / 2" NPT(M) | |
| 32.3 kg | | 1 NPT(F) | |

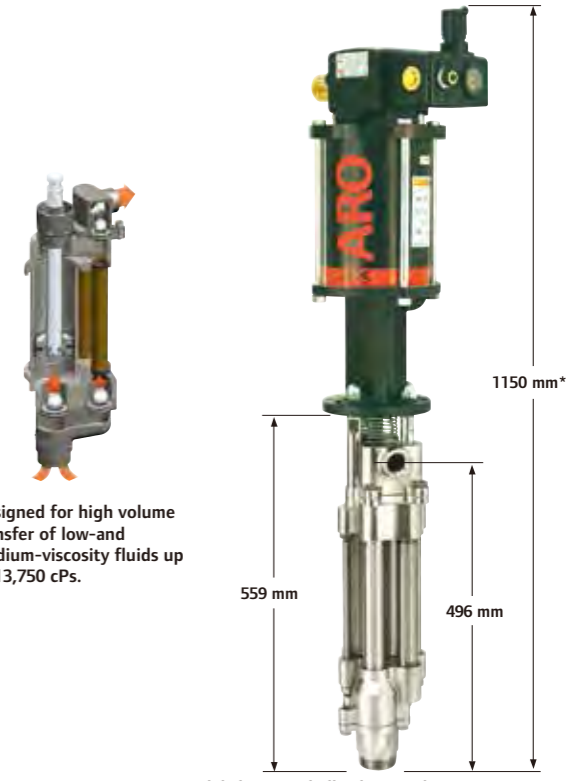

Designed for high volume transfer of low-and medium-viscosity fluids up to 13,750 cPs.

Model shown w/ball valve regulator
*For models without ball valve regulator subtract 52.83mm



Transfer and Supply

| Pump model no. (1) | Lower pump | Plunger material | Packings (upper + lower) | ServiceKit (2) |
|--------------------|------------|-----------------------------------|---|----------------|
| AF0604M11FF48 | 67200-C4B | 300 Series / CF8M stainless steel | UHMW-PE + UHMW-PE | 637317-C4B |
| AF0604M11KS48 | 67200-74B | | Glass-filled PTFE + Virgin PTFE | 637317-74B |
| AF0604M11HF48 | 67200-F4B | | UHMW-PE / Leather staggered + UHMW-PE | 637317-F4B |
| AF0604M11GF48 | 67200-P4B | | UHMW-PE/glass-filled PTFE + UHMW-PE | 637317-P4B |
| AF0604M11RS48 | 67200-R4B | | UHMW-PE/glass-filled PTFE + Virgin PTFE | 637317-R4B |
| | | | 17-4 stainless steel with ceramic coating | |

(1) Add "-1" to Model No. for Ball Valve Regulator
(2) Lower pump repair kit

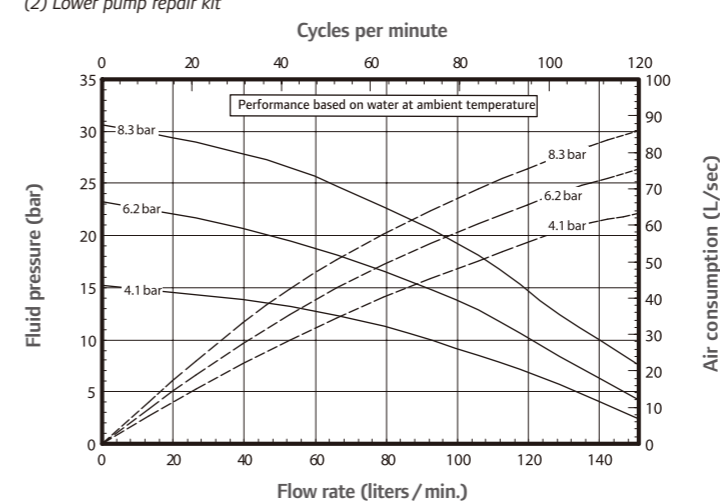

| Pump accessories | |
|------------------|-----------------------------|
| 67445-2 | High performance muffler |
| 23644-400 | AroStop valve |
| 67187-1 | Mounting post |
| 637489 | Universal motor service kit |
| 67442 | Ball Valve Regulator |

5:1
124 l/min

AFX Series

4-ball piston pump

| Specifications | | | |
|-------------------|--------------------|---------------------------|----------------------------|
| ?:1 | 5:1 | Max. bar | 10 - 48 bar |
| Motor | 8" (203 mm) | Cycle/min. | 70 cycles/min. |
| Motor | 6" (152 mm) | 1 min. | 124 l/min. @70 cycles/min. |
| AIR | 3/4" NPT(F) | 1 cycle | 1771 cc |
| Max. bar | 2.1 - 8.3 bar | For 1litre | 0.56 cycle |
| Headphones | 86.8 dBA @ 4.1 bar | 1 1/2" NPT(F) / 2" NPT(M) | |
| Weight | 43.5 kg | 1 NPT(F) | |

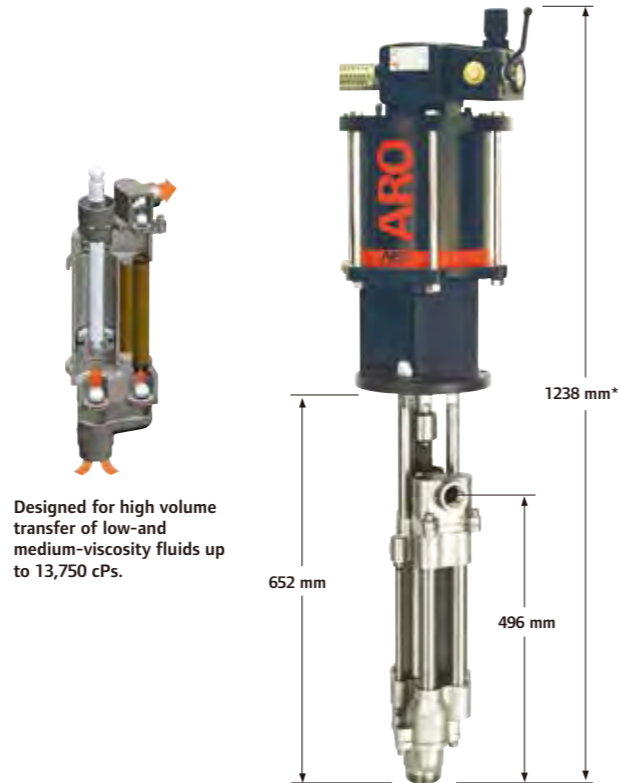

Designed for high volume transfer of low-and medium-viscosity fluids up to 13,750 cPs.

Model shown w/ball valve regulator
*For models without ball valve regulator subtract 52.83mm



| Pump model no. (1) | Lower pump | Plunger material | Packings (upper + lower) | ServiceKit (2) | |
|--------------------|------------|-----------------------------------|---|-------------------------------------|------------|
| AF0805M11FF48 | 67201-C4G | 300 Series / CF8M stainless steel | 17-4 stainless steel with ceramic coating | UHMW-PE + UHMW-PE | 637318-C4G |
| AF0805M11GF48 | 67201-P4G | | | UHMW-PE/glass-filled PTFE + UHMW-PE | 637318-P4G |

(1) Add "-1" to Model No. for Ball Valve Regulator
(2) Lower pump repair kit

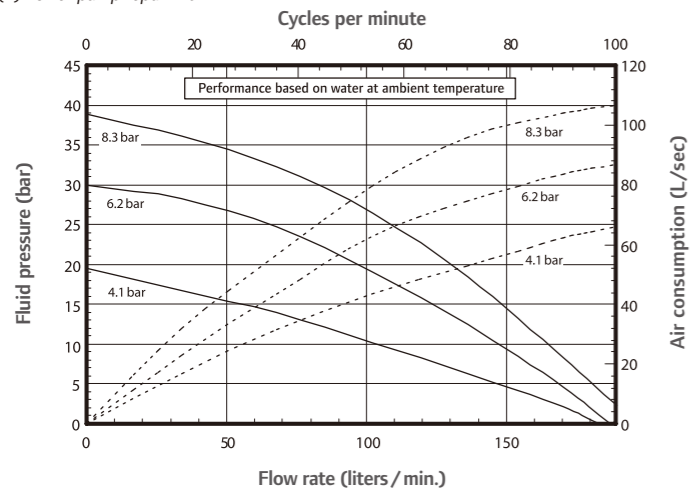

| Pump accessories | |
|------------------|-----------------------------|
| 67445-3 | High performance muffler |
| 635043 | AroStop valve |
| 67187-1 | Mounting post |
| 637489 | Universal motor service kit |
| 67442 | Ball Valve Regulator |

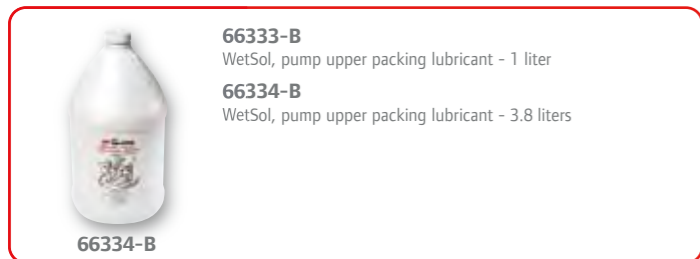

7:1
88.8 l/min

AFX Series

4-ball piston pump

| Specifications | | | |
|-------------------|--------------------|---------------------------|-----------------------------|
| ?:1 | 7:1 | Max. bar | 15 - 70 bar |
| Motor | 8" (203 mm) | Cycle/min. | 70 cycles/min. |
| Motor | 6" (152 mm) | 1 min. | 88.8 l/min. @70 cycles/min. |
| AIR | 3/4" NPT(F) | 1 cycle | 1270 cc |
| Max. bar | 2.1 - 8.3 bar | For 1litre | 0.78 cycle |
| Headphones | 86.8 dBA @ 4.1 bar | 1 1/2" NPT(F) / 2" NPT(M) | |
| Weight | 43.5 kg | 1 NPT(F) | |

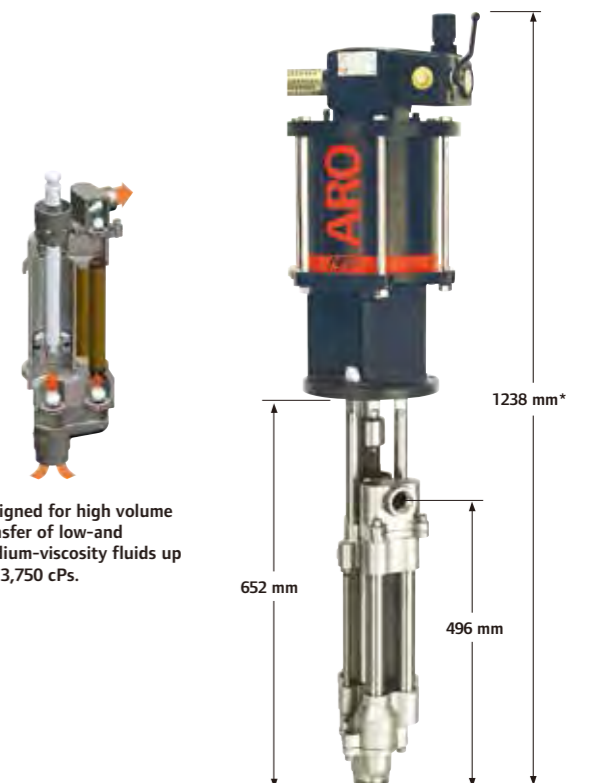

Designed for high volume transfer of low-and medium-viscosity fluids up to 13,750 cPs.

Model shown w/ball valve regulator
*For models without ball valve regulator subtract 52.83mm



| Pump model no. (1) | Lower pump | Plunger material | Packings (upper + lower) | ServiceKit (2) | |
|--------------------|------------|-----------------------------------|---|---|------------|
| AF0807M11FF48 | 67200-C4G | 300 Series / CF8M stainless steel | 17-4 stainless steel with ceramic coating | UHMW-PE + UHMW-PE | 637317-C4G |
| AF0807M11KS48 | 67200-74G | | | Class-filled PTFE + Virgin PTFE | 637317-74G |
| AF0807M11RS48 | 67200-R4G | | | Glass-filled PTFE / UHMW-PE staggered + Virgin PTFE | 637317-R4G |
| AF0807M11HF48 | 67200-F4G | | | UHMW-PE / Leather staggered + UHMW-PE | 637317-F4G |

(1) Add "-1" to Model No. for Ball Valve Regulator
(2) Lower pump repair kit

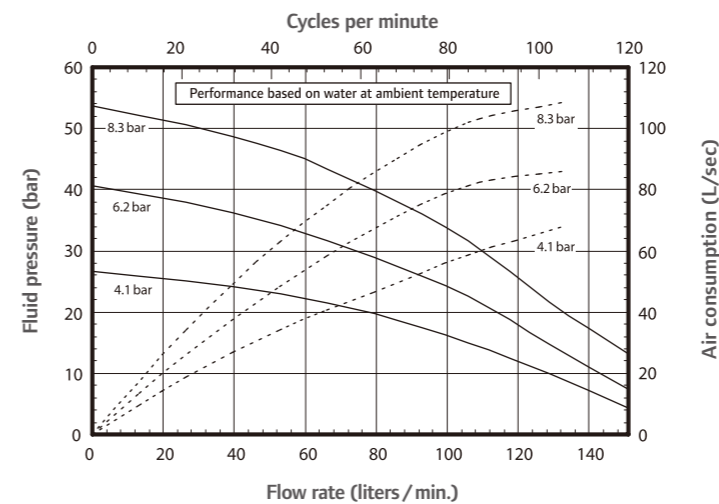

| Pump accessories | |
|------------------|-----------------------------|
| 67445-3 | High performance muffler |
| 635043 | AroStop valve |
| 67187-1 | Mounting post |
| 637489 | Universal motor service kit |
| 67442 | Ball Valve Regulator |

12:1
12.3 l/min

AFX Series

Chop check extrusion pump

| Specifications | | | |
|---------------------------|-----------------|-------------|------------------------------|
| ?:1 | 12:1 | Max. bar | 0 - 144 bar |
| Motor | 4 1/4" (108 mm) | Cycle/min. | 70 cycles/min. |
| Motor | 6" (152 mm) | 1 min. | 12.3 l/min. @ 60 cycles/min. |
| AIR | 1/2" NPT(F) | 1 cycle | 205 cc |
| Max. bar | 0 - 10.3 bar | For 1 litre | 4.9 cycles |
| 86.5 dBA @ 4.1 bar | | | Flange mount |
| 29 kg | | | 1" NPT(F) |

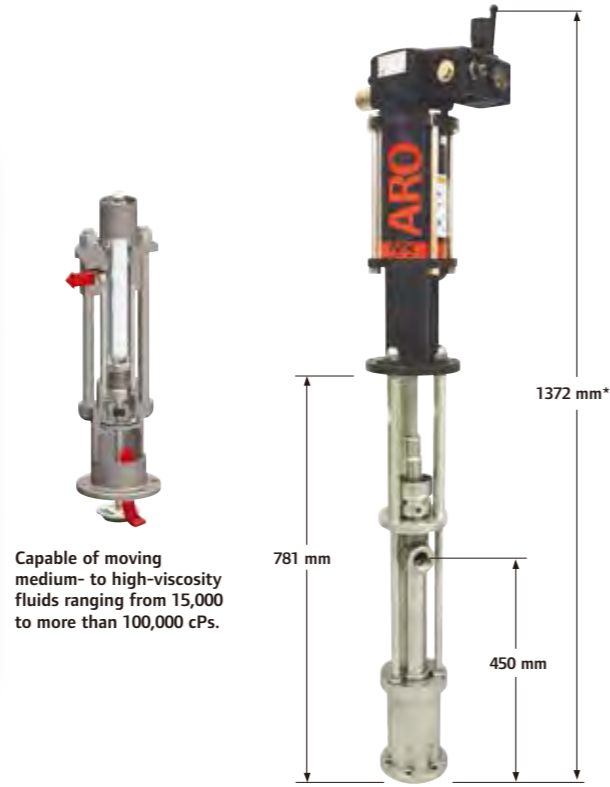

Capable of moving medium- to high-viscosity fluids ranging from 15,000 to more than 100,000 cPs.

Model shown w/ball valve regulator
*For models without ball valve regulator subtract 52.83mm

| Pump model no. (1) | Lower pump | Plunger material | Packings (upper + lower) | ServiceKit (2) |
|--------------------|-------------|-----------------------------|---|----------------|
| AF0412S11FF47 | 66243-C43-B | Carbon steel, nickel plated | UHMW-PE + UHMW-PE | 637071-C43-B |
| AF0412S11KK47 | 66243-343-B | | Glass-filled PTFE (upper & lower) | 637071-343-B |
| AF0412S11HH47 | 66243-G43-B | | UHMW-PE / Leather staggered (upper & lower) | 637071-G43-B |
| AF0412S11GF47 | 66243-P43-B | | UHMW-PE/glass-filled PTFE + UHMW-PE | 637071-P43-B |
| AF0412S11RK47 | 66243-R43-B | | Glass-filled PTFE/UHMW-PE + Glass-filled PTFE | 637071-R43-B |

(1) Add "-1" to Model No. for Ball Valve Regulator
(2) Lower pump repair kit

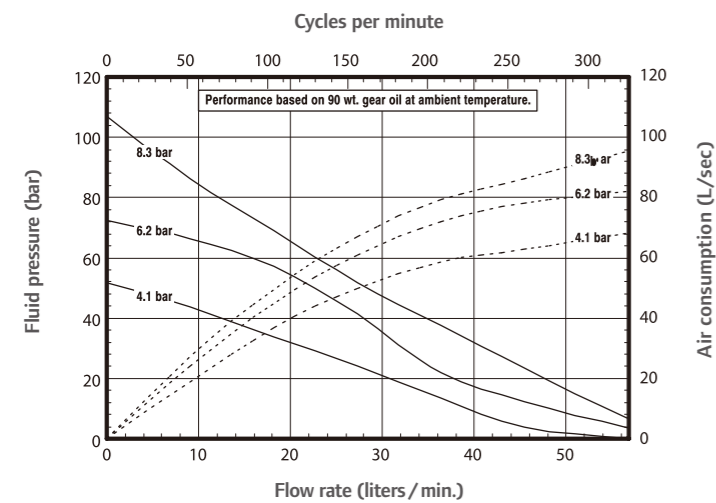

| Pump accessories | |
|------------------|-----------------------------|
| 67445-1 | High performance muffler |
| 635043 | AroStop valve |
| 65139 | Floor mount |
| 637489 | Universal motor service kit |
| 67442 | Ball Valve Regulator |

12:1
12.3 l/min

AFX Series

Chop check extrusion pump (continued)

12:1 ratio pump packages



| Model | Type | Pump model | RAM model | Follower plate (model, seal and material) | | Weight |
|------------------|----------------------|---------------|-----------|---|---------------------------|----------|
| TP0412S51FF47AA2 | 200 L / two-post RAM | AF0412S11FF47 | RM552S-C | 66516-1 | Double lip / polyurethane | Aluminum |
| TP0412S51KK47AA2 | | AF0412S11KK47 | | | | |
| TP0412S51HH47AA2 | | AF0412S11HH47 | | | | |
| TP0412S51GF47AA2 | | AF0412S11GF47 | | | | |
| TP0412S51GF47TA2 | | AF0412S11GF47 | | | | |

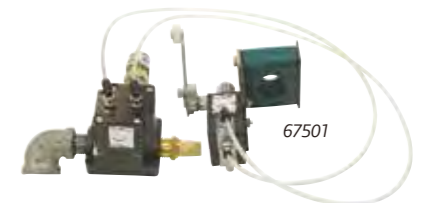
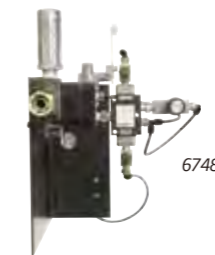

| Pump package accessories | | | |
|--------------------------|--------------------|---------------------------|-------------------------------|
| 66354-1 | 67481 | 67501 | 637472 |
| Pump stabilizing bracket | Cross over kit (1) | Low-level cut-off kit (2) | 200 L two-post RAM repair kit |

(1) Maintains fluid delivery in extrusion systems. Can activate alarm to alert maintenance to change empty fluid container.
(2) Used to shut off air supply to pump when material container is empty or near-empty.

13:1
46.3 l/min

AFX Series

Chop check extrusion pump

| Specifications | | | |
|-------------------|--------------------|-------------|------------------------------|
| ?:1 | 13:1 | Max. bar | 27 - 130 bar |
| Motor | 8" (203 mm) | Cycle/min. | 70 cycles/min. |
| Motor | 6" (152 mm) | 1 min. | 46.3 l/min. @ 70 cycles/min. |
| AIR | 3/4" NPT(F) | 1 cycle | 662 cc |
| Max. bar | 2.1 - 8.3 bar | For 1 litre | 1.5 cycles |
| Headphones | 86.8 dBA @ 4.1 bar | | Flange mount |
| Weight | 56.9 kg | | 1 1/2" NPT(F) |

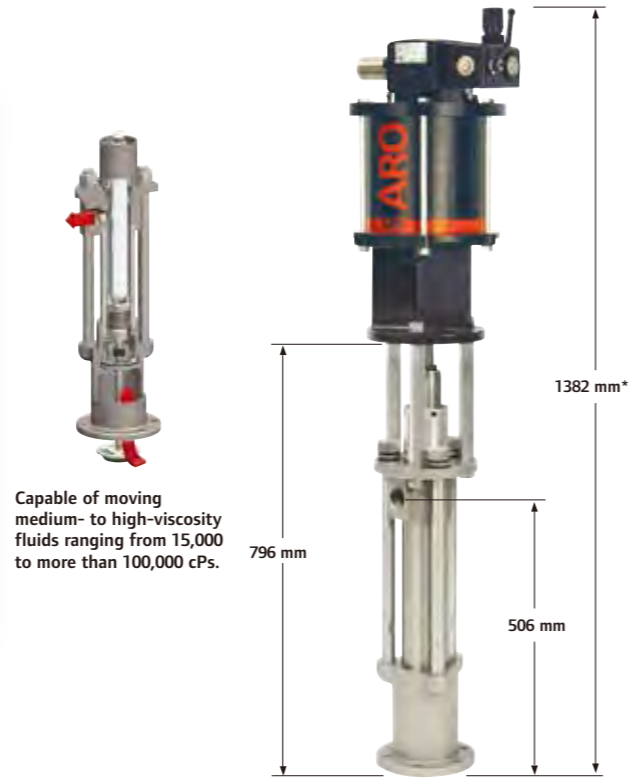

Capable of moving medium- to high-viscosity fluids ranging from 15,000 to more than 100,000 cPs.

Model shown w/ball valve regulator
*For models without ball valve regulator subtract 52.83mm

| Pump model no. (1) | Lower pump | Plunger material | Packings (upper lower) | ServiceKit (2) | |
|--------------------|-------------|-----------------------------|----------------------------|---------------------------------------|--------------|
| AF0813S11FF44 | 66236-C4E-B | Carbon steel, nickel plated | Carbon steel / hard chrome | UHMW-PE + UHMW-PE | 637128-C44-B |
| AF0813S11GF44 | 66236-P4E-B | | | UHMW-PE/glass-filled PTFE + UHMW-PE | 637128-P44-B |
| AF0813S11HF44 | 66236-F4E-B | | | UHMW-PE / Leather staggered + UHMW-PE | 637128-F44-B |
| AF0813S11PF14 | 66236-J3E-B | | | Polyurethane + UHMW-PE | 637128-J34-B |

(1) Add "-1" to Model No. for Ball Valve Regulator
(2) Lower pump repair kit

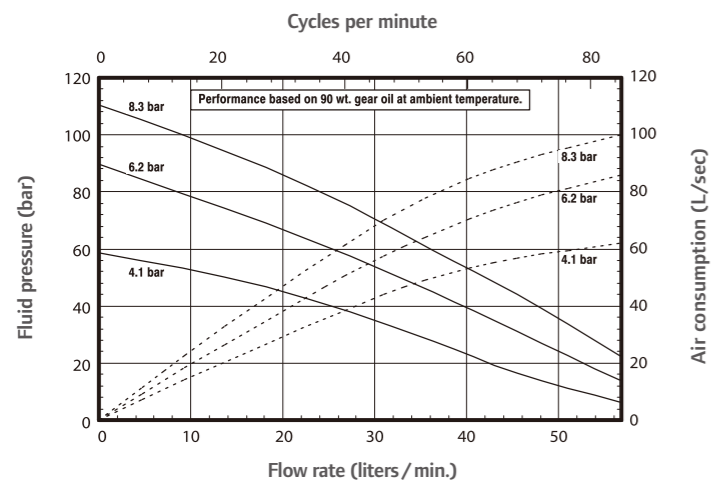

| Pump accessories | |
|------------------|-----------------------------|
| 67445-3 | High performance muffler |
| 635043 | AroStop valve |
| 65139 | Floor mount |
| 637489 | Universal motor service kit |
| 67442 | Ball Valve Regulator |

13:1
46.3 l/min

AFX Series

Chop check extrusion pump (continued)

13:1 ratio pump packages



| Model | Type | Pump model | Floor mount kit | Material supply hose | Hose with fittings | Ball valve | Weight |
|------------------|-------------|-----------------|-----------------|----------------------|--------------------|------------|---------|
| FM0813S11PF14001 | Floor mount | AF0813S11PF14-1 | 65139 | 628088-7 | 628089-6 | 67073 | 67.5 kg |

| Model | Type | Pump model | RAM model | Follower plate (model, seal and material) | | Weight |
|------------------|----------------------|---------------|-----------|---|------------------------------------|----------|
| TP0813S51HF44AA2 | 200 L / two-post RAM | AF0813S11HF44 | RM552S-C | 66517-1 | Double lip / polyurethane Aluminum | 199.9 kg |

| Pump package accessories | | | |
|--------------------------|--------------------|---------------------------|-------------------------------|
| 66353-1 | 67481 | 67501 | 637472 |
| Pump stabilizing bracket | Cross over kit (1) | Low-level cut-off kit (2) | 200 L two-post RAM repair kit |

(1) Maintains fluid delivery in extrusion systems. Can activate alarm to alert maintenance to change empty fluid container.
(2) Used to shut off air supply to pump when material container is empty or near-empty.

20:1
46.3 l/min

AFX Series

Chop check extrusion pump

| Specifications | | | |
|-------------------|--------------------|-------------|------------------------------|
| ?:1 | 20:1 | Max. bar | 40 - 155 bar |
| Motor | 10" (254 mm) | Cycle/min. | 70 cycles/min. |
| Motor | 6" (152 mm) | 1 min. | 46.3 l/min. @ 70 cycles/min. |
| AIR | 3/4" NPT(F) | 1 cycle | 662 cc |
| Max. bar | 2.1 - 6.2 bar | For 1 litre | 1.5 cycles |
| Headphones | 89.8 dBA @ 4.1 bar | | Flange mount |
| Weight | 65.3 kg | | 1 1/2" NPT(F) |

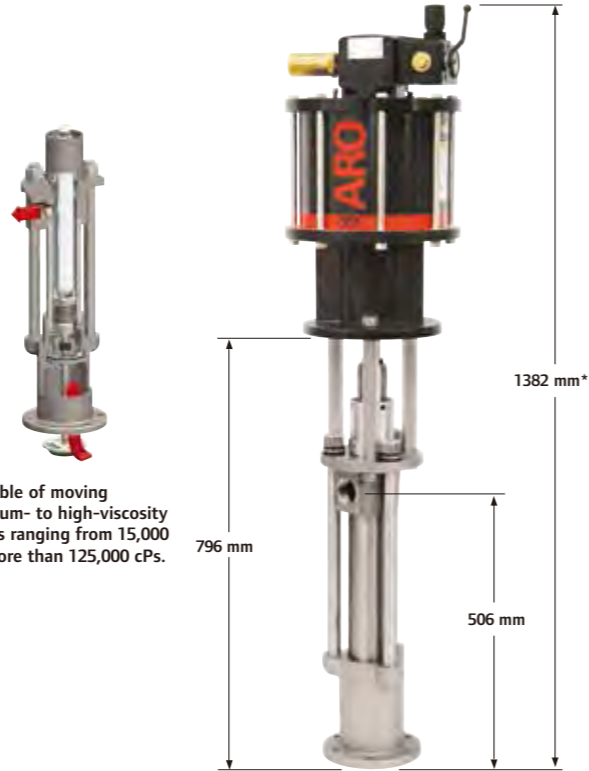

Capable of moving medium- to high-viscosity fluids ranging from 15,000 to more than 125,000 cPs.

Model shown w/ball valve regulator
*For models without ball valve regulator subtract 52.83mm

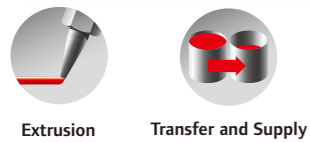

20:1
46.3 l/min

AFX Series

Chop check extrusion pump (continued)

20:1 ratio pump packages



| Pump model no. (1) | Lower pump | Plunger material | Packings (upper + lower) | ServiceKit (2) |
|--------------------|-------------|-----------------------------|---------------------------------------|----------------|
| AF1020S11FF44 | 66236-C4E-B | Carbon steel, nickel plated | UHMW-PE + UHMW-PE | 637128-C44-B |
| AF1020S11HF44 | 66236-F4E-B | | UHMW-PE / Leather staggered + UHMW-PE | 637128-F44-B |
| AF1020S11PF14 | 66236-J3E-B | | Polyurethane + UHMW-PE | 637128-J34-B |

(1) Add "-1" to Model No. for Ball Valve Regulator
(2) Lower pump repair kit

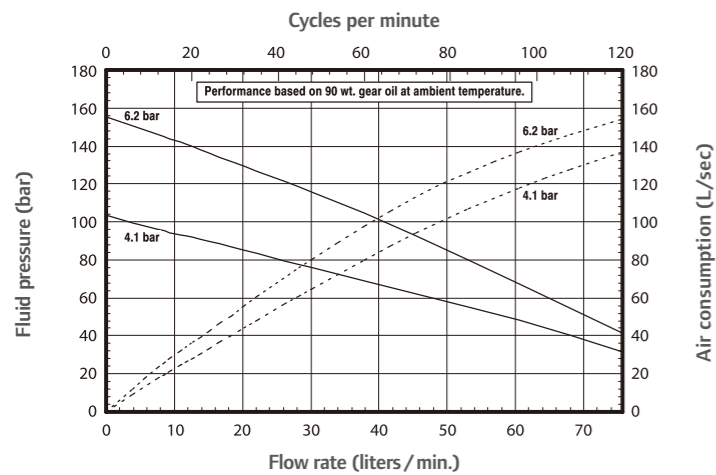

| Pump accessories | |
|------------------|-----------------------------|
| 67445-4 | High performance muffler |
| 635043 | AroStop valve |
| 65139 | Floor mount |
| 637489 | Universal motor service kit |
| 67442 | Ball Valve Regulator |

| Model | Type | Pump model | RAM model | Follower plate (model, seal and material) | Weight |
|------------------|----------------------|---------------|-----------|--|----------|
| TPD020S51FF44AA2 | 200 L / two-post RAM | AF1020S11FF44 | RM552S-C | 66517-1 Double lip / polyurethane Aluminum | 204.8 kg |

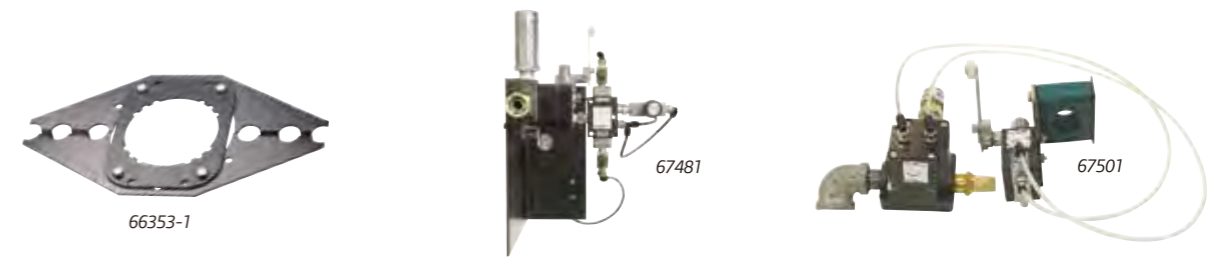

| Pump package accessories | | | |
|--------------------------|--------------------|---------------------------|-------------------------------|
| 66353-1 | 67481 | 67501 | 637472 |
| Pump stabilizing bracket | Cross over kit (1) | Low-level cut-off kit (2) | 200 L two-post RAM repair kit |

(1) Maintains fluid delivery in extrusion systems. Can activate alarm to alert maintenance to change empty fluid container.
(2) Used to shut off air supply to pump when material container is empty or near-empty.

23:1

6.9 l/min

AFX Series

Chop check extrusion pump

| Specifications | | | |
|-------------------|--------------------|-------------|-----------------------------|
| ?:1 | 23:1 | Max. bar | 0 - 254 bar |
| Motor | 4 1/4" (108 mm) | Cycle/min. | 60 cycles/min. |
| Motor | 6" (152 mm) | 1 min. | 6.9 l/min. @ 60 cycles/min. |
| AIR | 1/2" NPT(F) | 1 cycle | 113 cc |
| Max. bar | 0 - 10.3 bar | For 1 litre | 8.8 cycles |
| Headphones | 86.5 dBA @ 4.1 bar | | Flange mount |
| Weight | 28.9 kg | | 1" NPT(F) |



Extrusion



Transfer and Supply

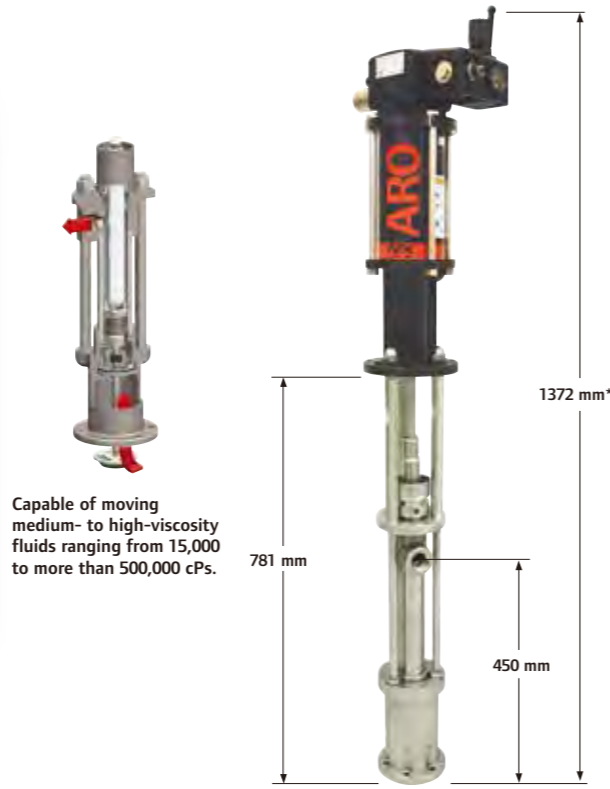

Capable of moving medium- to high-viscosity fluids ranging from 15,000 to more than 500,000 cPs.

Model shown w/ball valve regulator
*For models without ball valve regulator subtract 52.83mm

| Pump model no. (1) | .Lower pump | Plunger material | Packings (upper + lower) | ServiceKit (2) |
|--------------------|-------------|---|---|----------------|
| AF0423S11FF47 | 66266-C43-B | Carbon steel, nickel plated 17-4 stainless steel / hard chrome | UHMW-PE + UHMW-PE | 637074-C43-B |
| AF0423S11KK47 | 66266-343-B | | Glass-filled PTFE (upper & lower) | 637074-343-B |
| AF0423S11HH47 | 66266-G43-B | | UHMW-PE / Leather staggered (upper & lower) | 637074-G43-B |
| AF0423S11RK47 | 66266-R43-B | | Glass-filled PTFE/UHMW-PE + Glass-filled PTFE | 637074-R43-B |

(1) Add "-1" to Model No. for Ball Valve Regulator
(2) Lower pump repair kit

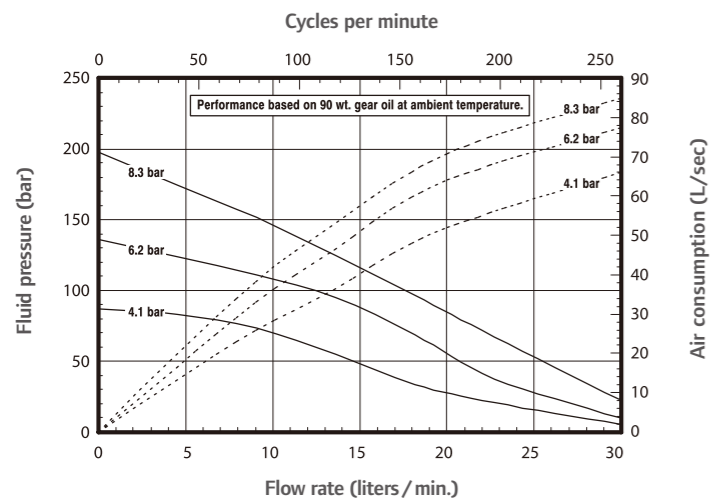

| Pump accessories | |
|------------------|-----------------------------|
| 67445-1 | High performance muffler |
| 23644-400 | AroStop valve |
| 65139 | Floor mount |
| 637489 | Universal motor service kit |
| 67442 | Ball Valve Regulator |

23:1

6.9 l/min

AFX Series

Chop check extrusion pump (continued)

23:1 ratio pump packages

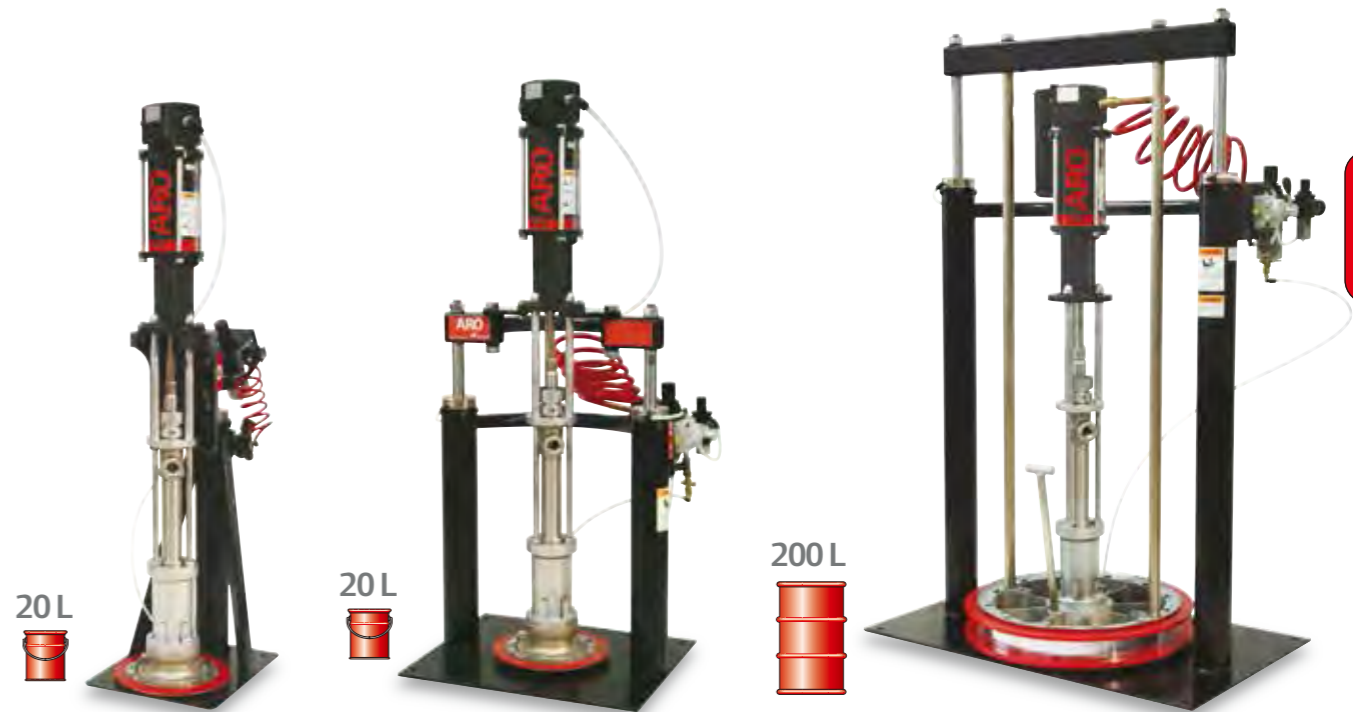

| Model | Type | Pump model | RAM model | Follower plate (model, seal and material) | Weight |
|------------------|------------------------|---------------|-----------|---|----------|
| SP0423S21FF47E32 | 20 L / single-post RAM | AF0423S11FF47 | RM051S-C | 67342-1 Single lip, polyethylene/urethane Carbon steel, nickel plated | 74.8 kg |
| TP0423S21FF47E32 | 20 L / two-post RAM | | RM052S-C | | 102.4 kg |
| TP0423S51FF47AA2 | | AF0423S11FF47 | RM552S-C | 66516-1 Double lip / polyurethane Aluminum | 188.1 kg |
| TP0423S51HH47AA2 | 200 L / two-post RAM | AF0423S11HH47 | | | |
| TP0423S51RK47AA2 | | AF0423S11RK47 | | | |

| Pump package accessories | | | |
|--------------------------|--|--|---|
| 66354-1 | 67482 (20 L / 1 post RAM) 67480 (20 L / 2 post RAM) 67481 (200 L / 2 post RAM) | 67502 (20 L / 1 post RAM) 67500 (20 L / 2 post RAM) 67501 (200 L / 2 post RAM) | 637465 (20 L / 1 post RAM) 637466 (20 L / 2 post RAM) 637472 (200 L / 2 post RAM) |
| Pump stabilizing bracket | Cross over kit | Low-level cut-off kit | RAM repair kit |

23:1

12.3 l/min

AFX Series

Chop check extrusion pump

| Specifications | | | |
|-------------------|--------------------|-------------|------------------------------|
| ?:1 | 23:1 | Max. bar | 0 - 290 bar |
| Motor | 6" (152 mm) | Cycle/min. | 60 cycles/min. |
| Motor | 6" (152 mm) | 1 min. | 12.3 l/min. @ 60 cycles/min. |
| AIR | 1/2" NPT(F) | 1 cycle | 205 cc |
| Max. bar | 0 - 10.3 bar | For 1 litre | 4.8 cycles |
| Headphones | 84.7 dBA @ 4.1 bar | | Flange mount |
| Weight | 30.5 kg | | 1" NPT(F) |

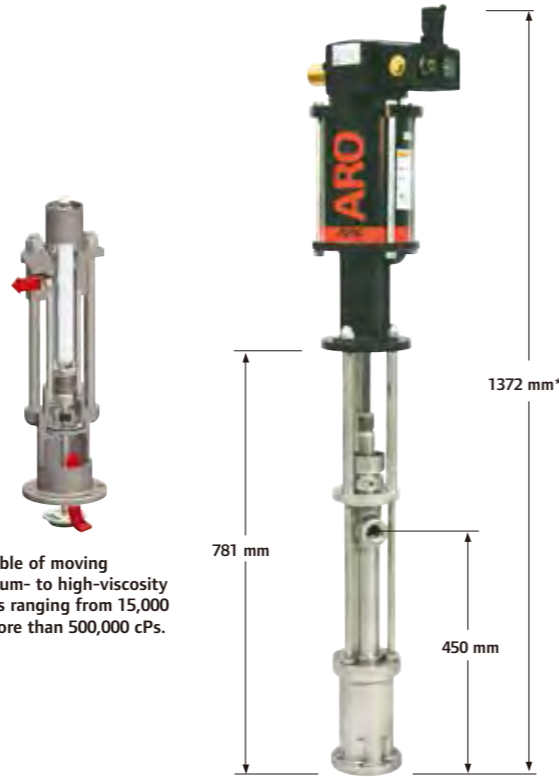

Capable of moving medium- to high-viscosity fluids ranging from 15,000 to more than 500,000 cPs.

Model shown w/ball valve regulator
*For models without ball valve regulator subtract 52.83mm

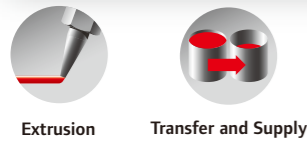

| Pump model no. (1) | Lower pump | Plunger material | Packings (upper + lower) | ServiceKit (2) |
|--------------------|-------------|---|---|----------------|
| AF0623S11FF47 | 66243-C43-B | Carbon steel, nickel plated 17-4 stainless steel / hard chrome | UHMW-PE + UHMW-PE | 637071-C43-B |
| AF0623S11KK47 | 66243-343-B | | Glass-filled PTFE (upper & lower) | 637071-343-B |
| AF0623S11HH47 | 66243-G43-B | | UHMW-PE / Leather staggered (upper & lower) | 637071-G43-B |
| AF0623S11HHD7(3) | 66243-G93-B | | | 637071-G93-B |
| AF0623S11GF47 | 66243-P43-B | | UHMW-PE/glass-filled PTFE + UHMW-PE | 637071-P43-B |
| AF0623S11RK47 | 66243-R43-B | | Glass-filled PTFE/UHMW-PE + Glass-filled PTFE | 637071-R43-B |

(1) Add "-1" to Model No. for Ball Valve Regulator
(2) Lower pump repair kit
(3) High capacity solvent cup with multiple wave spring

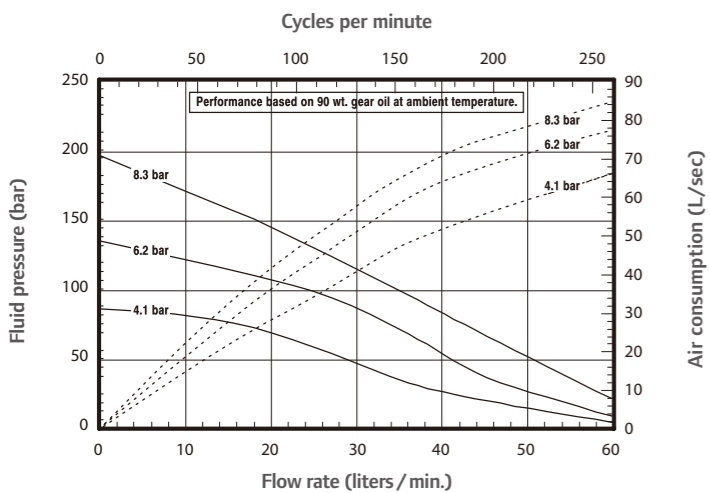

| Pump accessories | |
|------------------|-----------------------------|
| 67445-2 | High performance muffler |
| 23644-400 | AroStop valve |
| 65139 | Floor mount |
| 637489 | Universal motor service kit |
| 67442 | Ball Valve Regulator |

23:1

12.3 l/min

AFX Series

Chop check extrusion pump (continued)

23:1 ratio pump packages

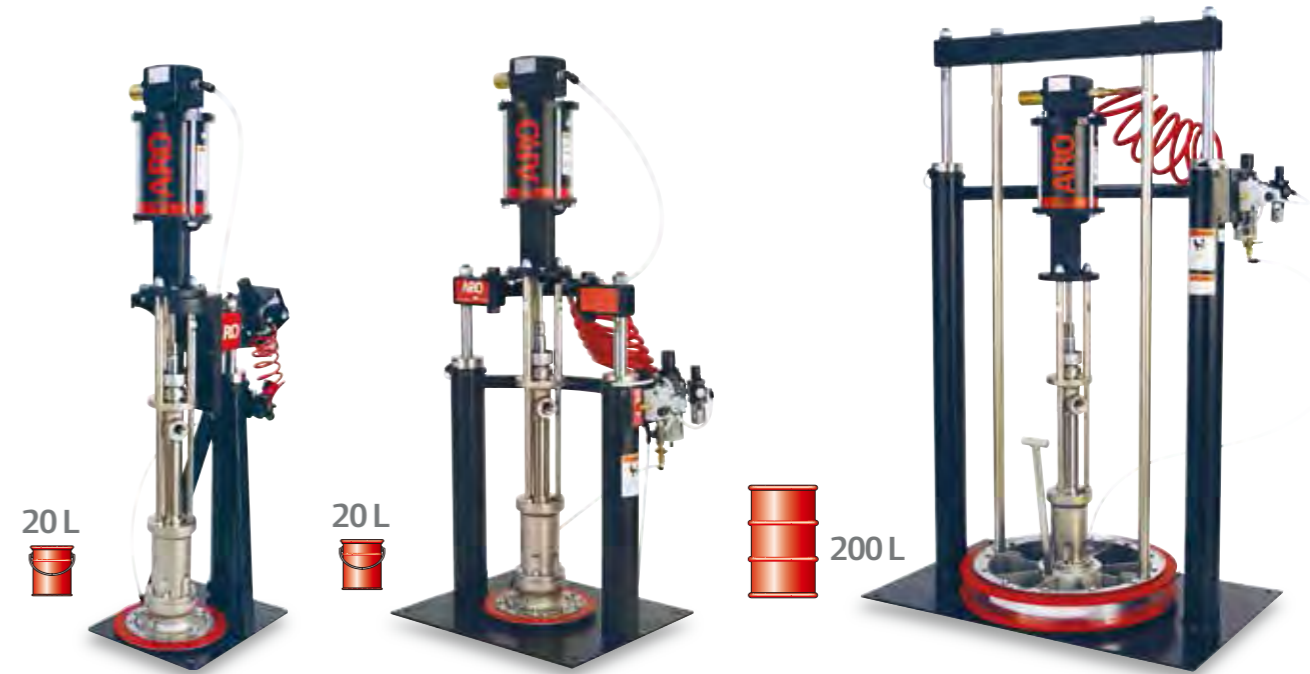

| Model | Type | Pump model | RAM model | Follower plate (model, seal and material) | Weight |
|------------------|------------------------|---------------|-----------|--|----------|
| SP0623S21FF47E32 | 20 L / single-post RAM | AF0623S11FF47 | RM051S-C | 67342-1 Single lip, polyethylene/urethane Carbon steel, nickel plated | 80.2 kg |
| SP0623S21RK47EC2 | | AF0623S11RK47 | | 66732 Double lip / nitrile | |
| TP0623S21FF47E32 | 20 L / two-post RAM | AF0623S11FF47 | RM052S-C | 67342-1 Single lip, polyethylene/urethane Carbon steel, nickel plated | 116.0 kg |
| TP0623S51FF47AA2 | 200 L / two-post RAM | AF0623S11FF47 | RM552S-C | 66516-1 Double lip / polyurethane Aluminum | 189.4 kg |
| TP0623S51HH47AA2 | | AF0623S11HH47 | | | |
| TP0623S51GF47AA2 | | AF0623S11GF47 | | | |
| TP0623S51FF47AN2 | | AF0623S11FF47 | | 67195-2 Double-tube / EPR Aluminum | |

| Pump package accessories | | | |
|--------------------------|--|--|---|
| 66354-1 | 67482 (20 L / 1 post RAM) 67480 (20 L / 2 post RAM) 67481 (200 L / 2 post RAM) | 67502 (20 L / 1 post RAM) 67500 (20 L / 2 post RAM) 67501 (200 L / 2 post RAM) | 637465 (20 L / 1 post RAM) 637466 (20 L / 2 post RAM) 637472 (200 L / 2 post RAM) |
| Pump stabilizing bracket | Cross over kit | Low-level cut-off kit | RAM repair kit |

28:1

22.7 l/min

AFX Series

Chop check extrusion pump

| Specifications | | | |
|-------------------|--------------------|-------------|------------------------------|
| ?:1 | 28:1 | Max. bar | 60 - 230 bar |
| Motor | 8" (203 mm) | Cycle/min. | 70 cycles/min. |
| Motor | 6" (152 mm) | 1 min. | 22.7 l/min. @ 70 cycles/min. |
| AIR | 3/4" NPT(F) | 1 cycle | 328 cc |
| Max. bar | 2.1 - 8.3 bar | For 1 litre | 3 cycles |
| Headphones | 86.8 dBA @ 4.1 bar | | Flange mount |
| Weight | 63.5 kg | | 1 1/4" NPT(F) |



Extrusion



Transfer and Supply



Capable of moving medium- to high-viscosity fluids ranging from 15,000 to more than 125,000 cPs.

Model shown w/ball valve regulator
*For models without ball valve regulator subtract 52.83mm

| Pump model no. (1) | Lower pump | Plunger material | Packings (upper + lower) | ServiceKit (2) | |
|--------------------|------------|-----------------------------|------------------------------------|-------------------|------------|
| AF0828S11FF47 | 67300-C4D | Carbon steel, nickel plated | 17-4 stainless steel / hard chrome | UHMW-PE + UHMW-PE | 637348-C4D |
| AF0828S11PF17 | 67300-J3D | | | | |

(1) Add "-1" to Model No. for Ball Valve Regulator

(2) Lower pump repair kit

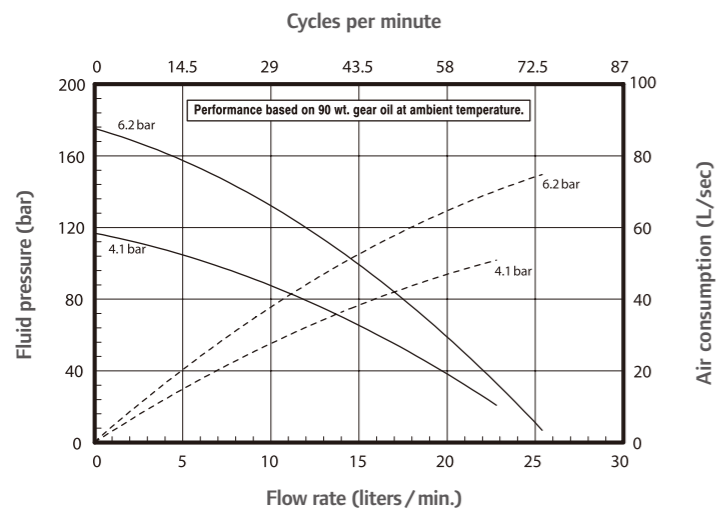

| Pump accessories | |
|------------------|-----------------------------|
| 67445-3 | High performance muffler |
| 635043 | AroStop valve |
| 65139 | Floor mount |
| 637489 | Universal motor service kit |
| 67442 | Ball Valve Regulator |

28:1

22.7 l/min

AFX Series

Chop check extrusion pump (continued)

28:1 ratio pump packages



| Model | Type | Pump model | RAM model | Follower plate (model, seal and material) | Weight |
|------------------|----------------------|---------------|-----------|--|----------|
| TPD828S51FF47AA2 | 200 L / two-post RAM | AF0828S11FF47 | RM552S-C | 66517-1 Double lip / polyurethane Aluminum | 222.4 kg |



| Pump package accessories | | | |
|--------------------------|----------------|-----------------------|-------------------------------|
| 66353-1 | 67481 | 67501 | 637472 |
| Pump stabilizing bracket | Cross over kit | Low-level cut-off kit | 200 L two-post RAM repair kit |



66333-B
WetSol, pump upper packing lubricant - 1 liter

66334-B
WetSol, pump upper packing lubricant - 3.8 liters

Recommended for use in piston pumps solvent cups - Increase the performance and service life of pumping equipment.

30:1

46.3 l/min

AFX Series

Chop check extrusion pump

| Specifications | | | |
|----------------|------------------|--|------------------------------|
| ?:1 | 30:1 | | 60 - 220 bar |
| | 12" (304 mm) | | 70 cycles/min. |
| | 6" (152 mm) | | 46.3 l/min. @ 70 cycles/min. |
| | 3/4" NPT(F) | | 662 cc |
| | 2.1 - 6.2 bar | | 1.5 cycle |
| | 93 dBA @ 4.1 bar | | Flange mount |
| | 69 kg | | 1 1/2" NPT(F) |



Capable of moving medium- to high-viscosity fluids ranging from 15,000 to more than 500,000 cPs.

Model shown w/ball valve regulator
*For models without ball valve regulator subtract 52.83mm

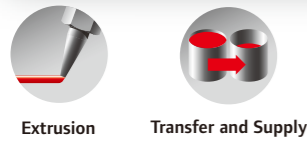

| Pump model no. (1) | Lower pump | Plunger material | Packings (upper + lower) | ServiceKit (2) | |
|--------------------|-------------|-----------------------------|----------------------------|---------------------------------------|--------------|
| AF1230S11FF44 | 66236-C4E-B | Carbon steel, nickel plated | Carbon steel / hard chrome | UHMW-PE + UHMW-PE | 637128-C44-B |
| AF1230S11HF44 | 66236-F4E-B | | | UHMW-PE / Leather staggered + UHMW-PE | 637128-F44-B |
| AF1230S11PF14 | 66236-J3E-B | | | Polyurethane + UHMW-PE | 637128-J34-B |

(1) Add "-1" to Model No. for Ball Valve Regulator
(2) Lower pump repair kit

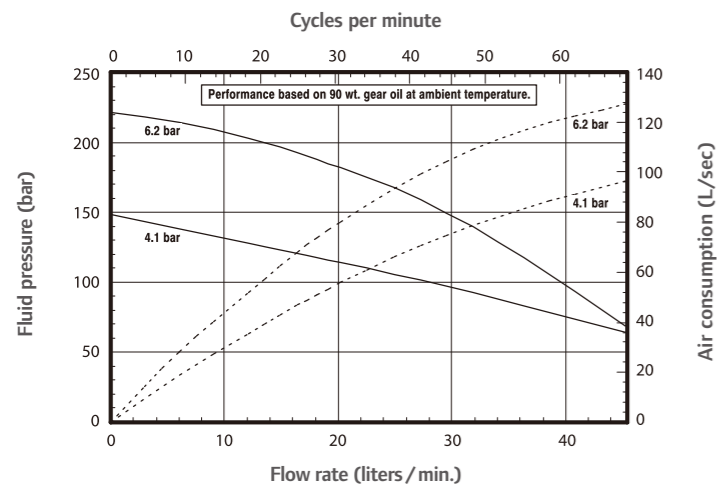

| Pump accessories | |
|------------------|-----------------------------|
| 67445-5 | High performance muffler |
| 635043 | AroStop valve |
| 65139 | Floor mount |
| 637489 | Universal motor service kit |
| 67442 | Ball Valve Regulator |

43:1

2.8 l/min

AFX Series

Chop check extrusion pump

| Specifications | | | |
|----------------|--------------------|--|-----------------------------|
| ?:1 | 43:1 | | 0 - 450 bar |
| | 4 1/4" (108 mm) | | 60 cycles/min. |
| | 4" (102 mm) | | 2.8 l/min. @ 60 cycles/min. |
| | 1/2" NPT(F) | | 46 cc |
| | 0 - 10.3 bar | | 21.7 cycles |
| | 86.5 dBA @ 4.1 bar | | Follower plate mounted |
| | 20 kg | | 1/2" NPT(F) |

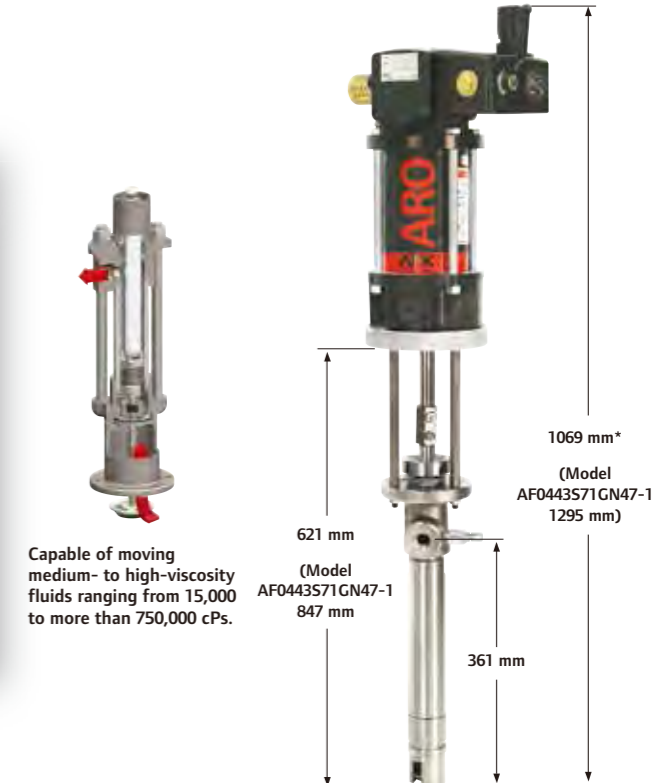

Capable of moving medium- to high-viscosity fluids ranging from 15,000 to more than 750,000 cPs.

Model shown w/ball valve regulator
*For models without ball valve regulator subtract 52.83mm



| Pump model no. (1) | Lower pump | Plunger material | Packings (upper + lower) | ServiceKit (2) | |
|--------------------|------------|-----------------------------|------------------------------------|--|------------|
| AF0443T21GN47 | 67101-P43 | 300 Series stainless steel | 17-4 stainless steel / hard chrome | UHMW-PE/glass-filled PTFE + UHMW-PE hydraulic gland type | 637291-P43 |
| AF0443T21GF47 | 67101-P48 | | | UHMW-PE/glass-filled PTFE + UHMW-PE | 637291-P48 |
| AF0443S21GN47 | 67100-P43 | Carbon steel, nickel plated | Carbon steel | UHMW-PE/glass-filled PTFE + UHMW-PE hydraulic gland type | 637290-P43 |
| AF0443S21GF47 | 67100-P48 | | | UHMW-PE/glass-filled PTFE + UHMW-PE | 637290-P48 |

(1) Add "-1" to Model No. for Ball Valve Regulator
(2) Lower pump repair kit

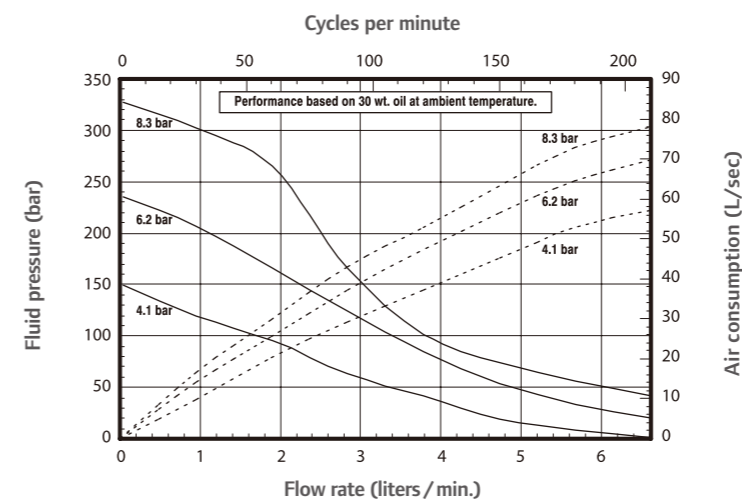

| Pump accessories | |
|------------------|--------------------------------|
| 67445-1 | High performance muffler |
| 23644-400 | AroStop valve |
| 67136 | Floor / follower plate adapter |
| 637489 | Universal motor service kit |
| 67442 | Ball Valve Regulator |

43:1 ratio pump packages



| Model | Type | Pump model | Cart / RAM | Follower plate (model, seal and material) | | | Weight |
|------------------|------------------------|-----------------|------------|---|-----------------------------------|-----------------------------|----------|
| CL0443S21GN47E31 | Cart-mounted pump | AF0443S21GN47-1 | 67075-B | 651840-1 | Single lip, polyethylene/urethane | Carbon steel, nickel plated | 67.5 kg |
| CL0443T21GN47S31 | | AF0443T21GN47-1 | | 651841-1 | Single lip, polyethylene/urethane | Stainless steel | |
| SP0443S21GN47E52 | 20 L / single-post RAM | AF0443S21GN47 | RM0515-C | 651840-3 | Single lip, nitrile/polyethylene | Carbon steel, nickel plated | 68.0 kg |
| SPD443S21GN47E32 | | AF0443S21GN47 | | 651840-1 | Single lip, nitrile/polyethylene | Carbon steel, nickel plated | |
| SPD443S21GN47A72 | | AF0443S21GN47 | | 67347-2 | Single tube, EPR | Aluminum | |
| SP0443T21GN47S32 | | AF0443T21GN47 | | 651841-1 | Single lip, urethane/polyethylene | Stainless steel | |
| TP0443S21GN47E52 | | AF0443S21GN47 | | 651840-3 | Single lip, nitrile/polyethylene | Carbon steel, nickel plated | |
| TP0443T21GN47S32 | 20 L / two-post RAM | AF0443T21GN47 | RM0525-C | 651841-1 | Single lip, urethane/polyethylene | Stainless steel | 101.5 kg |
| TP0443S21GN47E32 | | AF0443S21GN47 | | 651840-1 | Single lip, urethane/polyethylene | Carbon steel, nickel plated | |
| TPD443S31GN47E32 | 60L / two-post RAM | AF0443S21GN47 | RM0725-C | 651840-1 | Single lip, nitrile/polyethylene | Carbon steel, nickel plated | 107.2 kg |
| TPD443S31GN47A72 | | AF0443S21GN47 | | 67347-2 | Single tube, EPR | Aluminum | |
| TPD443S41GN47E32 | | AF0443S21GN47 | | 651840-1-GL | Single lip, nitrile/polyethylene | Carbon steel, nickel plated | |



F35341-400

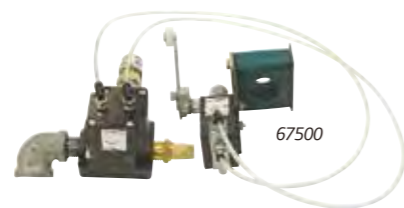

67500

| Pump package accessories | | | | |
|--------------------------|----------------|-----------------------|---------------------------------|------------------------------|
| F35341-400 | 67448 | 67500 | 637465 | 637466 |
| Air filter | Cross over kit | Low-level cut-off kit | 20 L single-post RAM repair kit | 20 L two-post RAM repair kit |

44:1
14.3 l/min
AFX Series

Chop check extrusion pump

| Specifications | | | |
|----------------|--------------------|--------------|------------------------------|
| Ratio | 44:1 | Max. bar | 90 - 410 bar |
| Motor | 8" (203 mm) | Cycle/min. | 70 cycles/min. |
| Motor | 6" (152 mm) | 1 min. | 14.3 l/min. @ 70 cycles/min. |
| AIR | 3/4" NPT(F) | 1 cycle | 205 cc |
| Max. bar | 2.1 - 8.3 bar | For 1 litre | 4.8 cycles |
| Headphones | 86.8 dBA @ 4.1 bar | Flange mount | |
| Weight | 55 kg | 1" NPT(F) | |

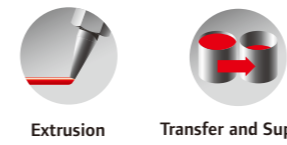

Extrusion Transfer and Supply

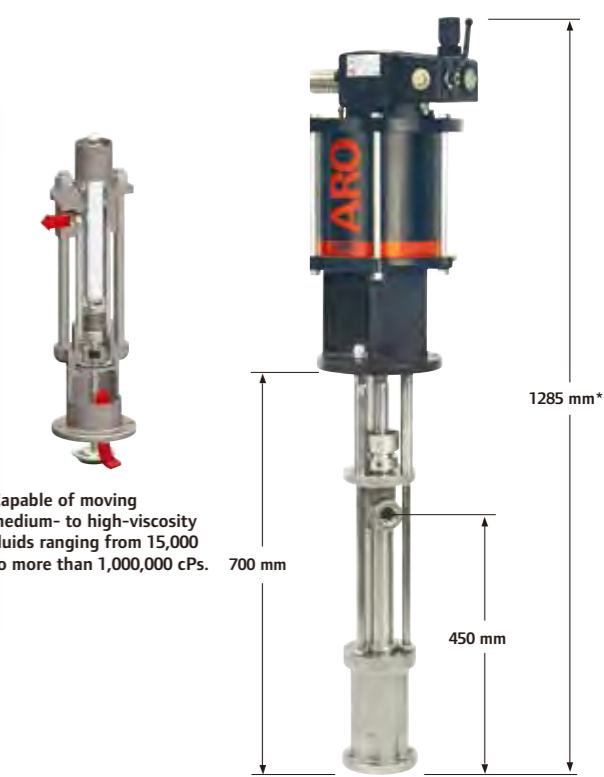

Capable of moving medium- to high-viscosity fluids ranging from 15,000 to more than 1,000,000 cPs.

Model shown w/ball valve regulator
*For models without ball valve regulator subtract 52.83mm

| Pump model no. (1) | Lower pump | Plunger material | Packings (upper + lower) | ServiceKit (2) |
|--------------------|-------------|-----------------------------|---|----------------|
| AF0844S11FF47 | 66243-C4D-B | Carbon steel, nickel plated | UHMW-PE + UHMW-PE | 637071-C4D-B |
| AF0844S11HH47 | 66243-G4D-B | | UHMW-PE / Leather staggered (upper & lower) | 637071-G4D-B |
| AF0844S11RK47 | 66243-R4D-B | | Glass-filled PTFE/UHMW-PE + Glass-filled PTFE | 637071-R4D-B |

(1) Add "-1" to Model No. for Ball Valve Regulator
(2) Lower pump repair kit

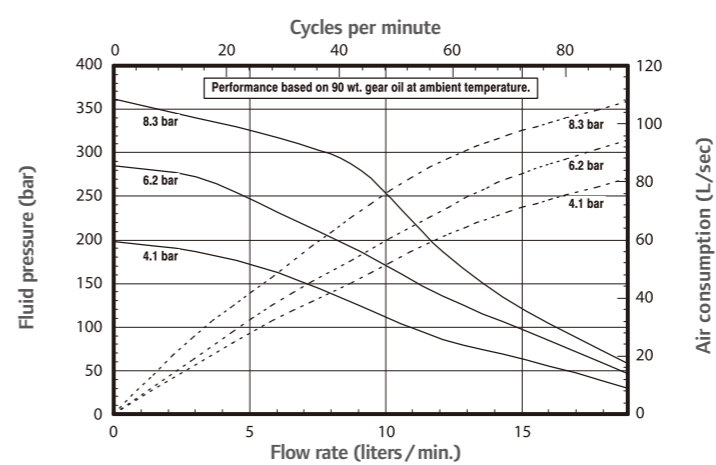

| Pump accessories | |
|------------------|-----------------------------|
| 67445-3 | High performance muffler |
| 635043 | AroStop valve |
| 65139 | Floor mount |
| 637489 | Universal motor service kit |
| 67442 | Ball Valve Regulator |

44:1 ratio pump packages

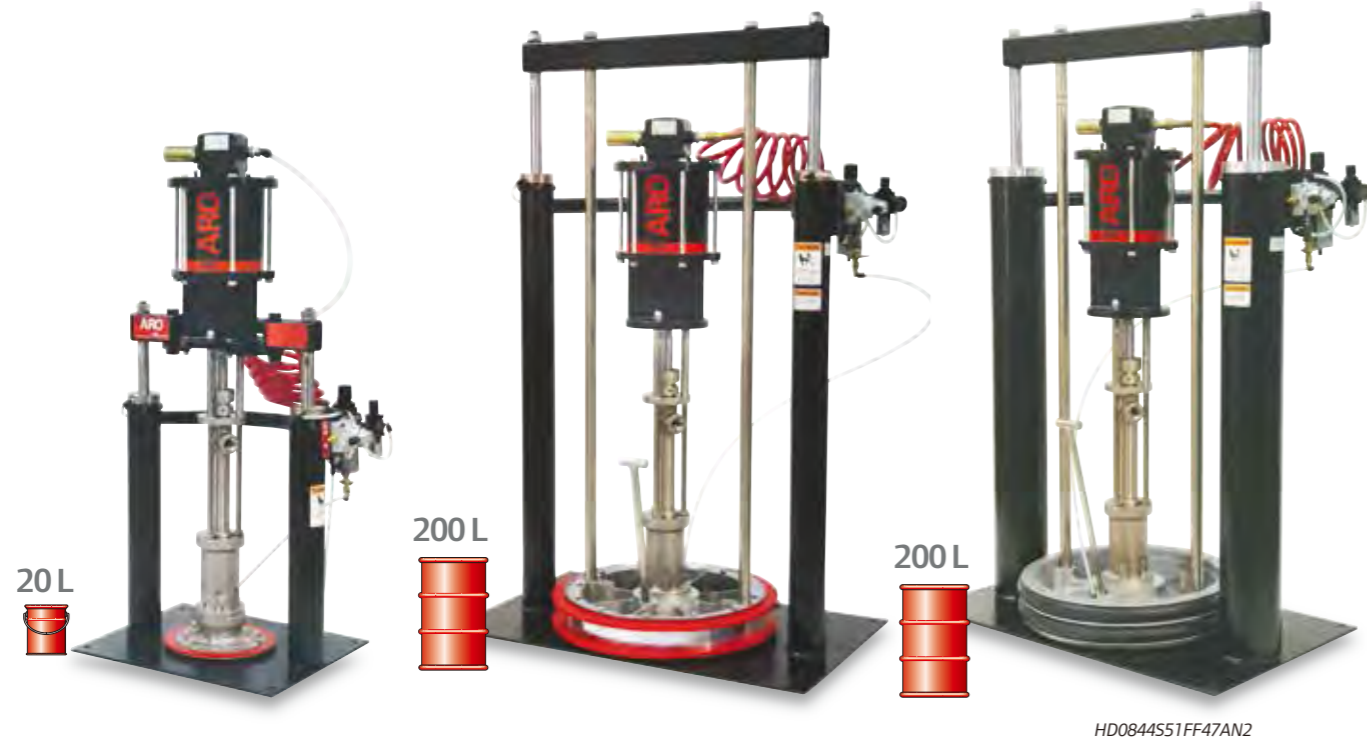

| Model | Type | Pump model | RAM model | Follower plate (model, seal and material) | | Weight | | |
|------------------|---------------------------------|---------------|-----------|---|---|----------|---------|---|
| TP0844S21FF47E32 | 20 L / two-post RAM | AF0844S11FF47 | RM052S-C | 67342-1 | Single lip, polyurethane/urethane Carbon steel, nickel plated | 140.5 kg | | |
| TP0844S51FF47AA2 | 200 L / two-post RAM | AF0844S11FF47 | RM552S-C | 66516-1 | Double lip / polyurethane Aluminum | 195.8 kg | | |
| TPD844S51HH47AA2 | | AF0844S11HH47 | | | | | | |
| TP0844S51RK47AA2 | | AF0844S11RK47 | | | | | | |
| TP0844S51FF47AN2 | | AF0844S11FF47 | | | | | 67195-2 | Double-tube / EPR Aluminum |
| TPD844S51HH47AM2 | | AF0844S11HH47 | | | | | 67195-1 | Double tube / Neoprene Aluminum |
| TP0844S51HH47AC2 | | AF0844S11HH47 | | | | | 66516 | Double lip / nitrile Aluminum |
| TP0844S51RK47AC2 | | AF0844S11RK47 | | | | | | |
| TP0844S51RK47TA2 | | AF0844S11RK47 | | | | | 66516-6 | Double lip / polyurethane Aluminum / PTFE coating |
| HD0844S51FF47AN2 | 200 L / heavy-duty two-post RAM | AF0844S11FF47 | RM552H-C | 67195-2 | Double-tube/EPR Aluminum | 243.9 kg | | |

| Pump package accessories | | | |
|--------------------------|-------------------------------|-------------------------------|---|
| 66353-1 | 67480 (20 L) 67481 (200 L) | 67500 (20 L) 67501 (200 L) | 637466 (20 L / 2 post RAM) 637472 (200 L / 2 post RAM) |
| Pump stabilizing bracket | Cross over kit | Low-level cut-off kit | RAM repair kit |

44:1
22.9 l/min

AFX Series

Chop check extrusion pump

| Specifications | | | |
|----------------|--------------------|---------------|------------------------------|
| Ratio | 44:1 | Max. bar | 90 - 270 bar |
| Motor | 10" (254 mm) | Cycle/min. | 70 cycles/min. |
| Motor | 6" (152 mm) | 1 min. | 22.9 l/min. @ 70 cycles/min. |
| AIR | 3/4" NPT(F) | 1 cycle | 328 cc |
| Max. bar | 2.1 - 6.2 bar | For 1 litre | 3 cycles |
| Headphones | 89.8 dBA @ 4.1 bar | Flange mount | |
| Weight | 64 kg | 1 1/4" NPT(F) | |

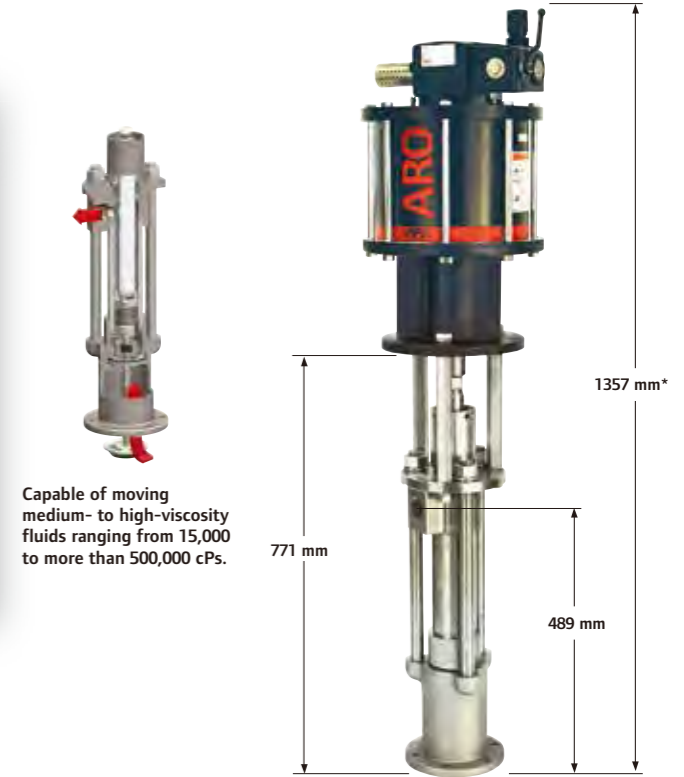

Capable of moving medium- to high-viscosity fluids ranging from 15,000 to more than 500,000 cPs.

Model shown w/ball valve regulator
*For models without ball valve regulator subtract 52.83mm

| Pump model no. (1) | Lower pump | Plunger material | Packings (upper + lower) | ServiceKit (2) | |
|--------------------|------------|-----------------------------|------------------------------------|-------------------|------------|
| AF1044S11FF47 | 67300-C4D | Carbon steel, nickel plated | 17-4 stainless steel / hard chrome | UHMW-PE + UHMW-PE | 637348-C4D |
| AF1044S11PF17 | 67300-J3D | | | | |

(1) Add "-1" to Model No. for Ball Valve Regulator
(2) Lower pump repair kit

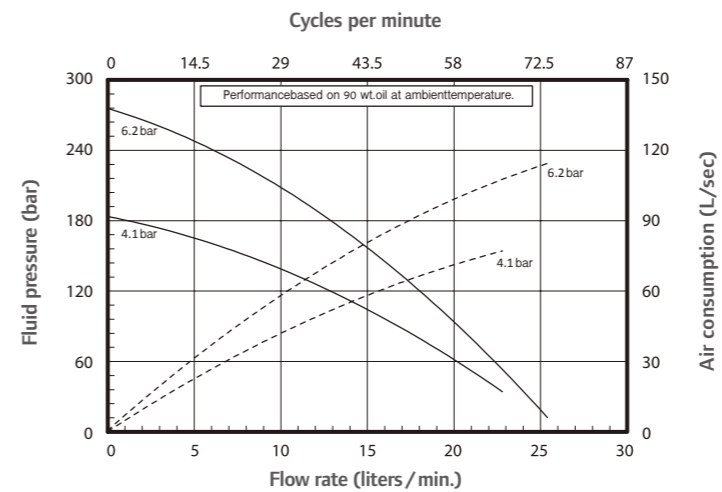

| Pump accessories | |
|------------------|-----------------------------|
| 67445-4 | High performance muffler |
| 635043 | AroStop valve |
| 65139 | Floor mount |
| 637489 | Universal motor service kit |
| 67442 | Ball Valve Regulator |

44:1 ratio pump packages



200 L

| Model | Type | Pump model | RAM model | Follower plate (model, seal and material) | | Weight |
|------------------|---------------------------------|---------------|-----------|---|------------------------|----------|
| TP1044S51FF47AM2 | 200 L / two-post RAM | AF1044S11FF47 | RM552S-C | 67196-1 | Double-tube / Neoprene | 204.8 kg |
| TP1044S51FF47AC2 | | | | 66517 | Double lip / nitrile | |
| HD1044S51FF47AN2 | 200 L / heavy-duty two-post RAM | AF1044S11FF47 | RM552H-C | 67196-2 | Double-tube / EPR | 252.9 kg |



| Pump package accessories | | | |
|--------------------------|-----------------------|--------------------------|---------------------------------|
| 67481 | 67501 | 66353-1 | 637472 |
| Cross over kit | Low-level cut-off kit | Pump stabilizing bracket | 200 L RAM repair kit (RM552H-C) |

46:1
6.9 l/min

AFX Series

Chop check extrusion pump

| Specifications | | | |
|----------------|--------------------|--------------|-----------------------------|
| Ratio | 46:1 | Max. bar | 0 - 515 bar |
| Motor | 6" (152 mm) | Cycle/min. | 60 cycles/min. |
| Motor | 6" (152 mm) | 1 min. | 6.9 l/min. @ 60 cycles/min. |
| AIR | 1/2" NPT(F) | 1 cycle | 113 cc |
| Max. bar | 0 - 10.3 bar | For 1 litre | 8.8 cycles |
| Headphones | 84.7 dBA @ 4.1 bar | Flange mount | |
| Weight | 30.4 kg | 1" NPT(F) | |

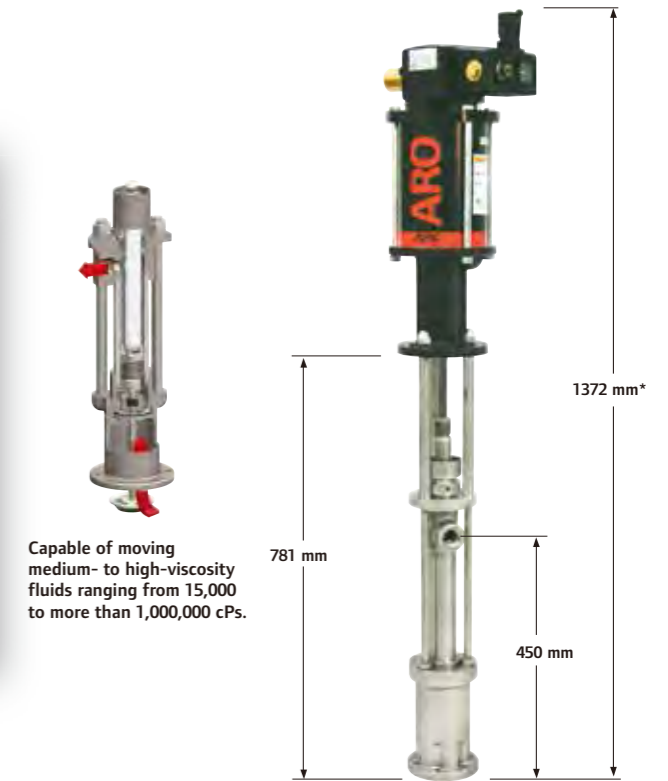
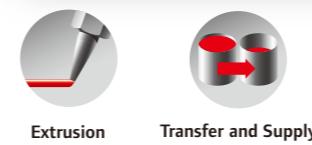

Capable of moving medium- to high-viscosity fluids ranging from 15,000 to more than 1,000,000 cPs.

Model shown w/ball valve regulator
*For models without ball valve regulator subtract 52.83mm

| Pump model no. (1) | Lower pump | Plunger material | Packings (upper + lower) | ServiceKit (2) | |
|--------------------|-------------|-----------------------------|------------------------------------|---|--------------|
| AF0646S11FF47 | 66266-C43-B | Carbon steel, nickel plated | 17-4 stainless steel / hard chrome | UHMW-PE + UHMW-PE | 637074-C43-B |
| AF0646S11GF47 | 66266-P43-B | | | UHMW-PE/glass-filled PTFE + UHMW-PE | 637074-P43-B |
| AF0646S11KK47 | 66266-343-B | | | Glass-filled PTFE (upper & lower) | 637074-343-B |
| AF0646S11HH47 | 66266-G43-B | | | UHMW-PE / Leather staggered (upper & lower) | 637074-G43-B |
| AF0646S11RK47 | 66266-R43-B | | | Class-filled PTFE/UHMW-PE + Class-filled PTFE | 637074-R43-B |

(1) Add "-1" to Model No. for Ball Valve Regulator
(2) Lower pump repair kit

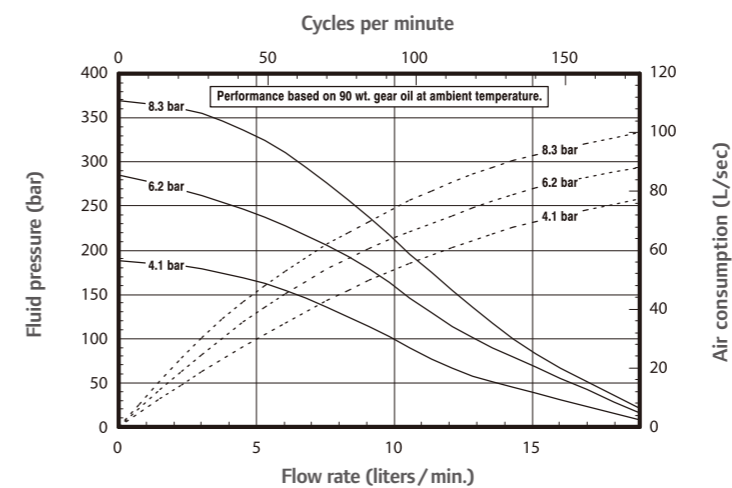

| Pump accessories | |
|------------------|-----------------------------|
| 67445-2 | High performance muffler |
| 23644-400 | AroStop valve |
| 65139 | Floor mount |
| 637489 | Universal motor service kit |
| 67442 | Ball Valve Regulator |

46:1 ratio pump packages



| Model | Type | Pump model | RAM model | Follower plate (model, seal and material) | | Weight | |
|------------------|------------------------|---------------|-----------|---|-----------------------------------|-----------------------------|----------|
| SP0646S21FF47E32 | 20 L / single-post RAM | AF0646S11FF47 | RM051S-C | 67342-1 | Single lip, polyurethane/urethane | Carbon steel, nickel plated | 78.4 kg |
| SPD646S21RK47A2 | | | | 67347-2 | Single tube / EPR | Aluminum | |
| TP0646S21FF47E32 | 20 L / two-post RAM | AF0646S11FF47 | RM052S-C | 67342-1 | Single lip, polyurethane/urethane | Carbon steel, nickel plated | 111.9 kg |
| TP0646S51FF47AA2 | 200 L / two-post RAM | AF0646S11FF47 | RM552S-C | 66516-1 | Double lip / polyurethane | Aluminum | 188.5 kg |
| TP0646S51GF47AA2 | | AF0646S11GF47 | | | | | |
| TP0646S51KK47AA2 | | AF0646S11KK47 | | | | | |
| TPD646S51HH47AA2 | | AF0646S11HH47 | | | | | |
| TPD646S51RK47AA2 | | AF0646S11RK47 | | | | | |
| TP0646S51KK47TA2 | 200 L / two-post RAM | AF0646S11KK47 | RM552S-C | 66516-6 | Double lip / polyurethane | Aluminum / PTFE coating | |

| Model | Type | Lower pump material | Packings (upper + lower) | Follower plate (model, seal and material) | Weight |
|-----------------|--------------------|----------------------------|--------------------------|--|----------|
| SCS052CSA0646T7 | 20L / two-post RAM | 300 Series stainless steel | UHMW-PE + UHMW-PE | Single tube / EPR Aluminum / PTFE coating | 205.0 kg |

| Model | Type | Pump model | Floor mount kit | Material supply hose | Hose with fittings | Ball valve | Weight |
|------------------|-------------|-----------------|-----------------|----------------------|--------------------|------------|---------|
| FM0646S11GF47001 | Floor mount | AF0646S11GF47-1 | 65138 | 628088-7 | 628089-6 | 67073 | 58.0 kg |

65:1
5.1 l/min

AFX Series

Chop check extrusion pump

| Specifications | | | |
|----------------|--------------------|-------------|-----------------------------|
| Ratio | 65:1 | Max. bar | 0 - 515 bar |
| Motor | 6" (152 mm) | Cycle/min. | 60 cycles/min. |
| Motor | 6" (152 mm) | 1 min. | 5.1 l/min. @ 60 cycles/min. |
| AIR | 1/2" NPT(F) | 1 cycle | 84 cc |
| Max. bar | 0 - 7.9 bar | For 1 litre | 11.9 cycles |
| Headphones | 84.7 dBA @ 4.1 bar | | Flange mount |
| Weight | 30.4 kg | | 3/4" NPT(F) |

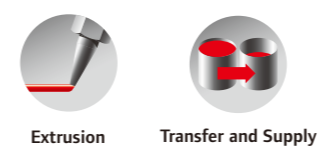
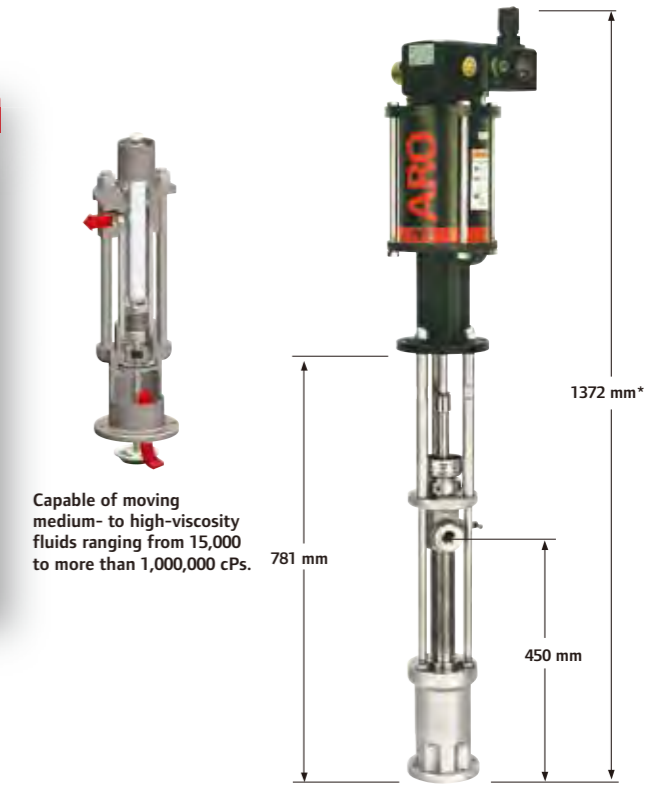

| Pump model no. (1) | Lower pump | Plunger material | Packings (upper + lower) | ServiceKit (2) | |
|--------------------|------------|-----------------------------|---|-------------------|------------|
| AF0665S11FF47 | 67348-C43 | Carbon steel, nickel plated | 17-4 stainless steel / hard chrome | UHMW-PE + UHMW-PE | 637464-C43 |
| AF0665S11GF47 | 67348-P43 | | UHMW-PE / Mineral-filled PTFE + UHMW-PE | 637464-P43 | |

(1) Add "-1" to Model No. for Ball Valve Regulator
(2) Lower pump repair kit

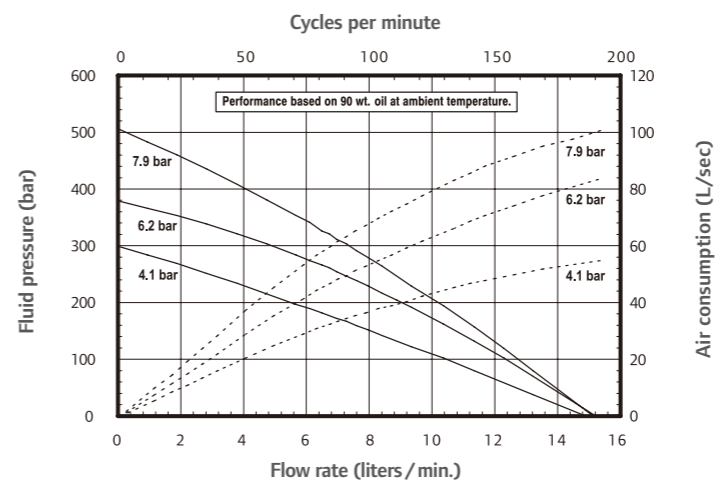

| Pump accessories | |
|------------------|-----------------------------|
| 67445-2 | High performance muffler |
| 23644-400 | AroStop valve |
| 65139 | Floor mount |
| 637489 | Universal motor service kit |
| 67442 | Ball Valve Regulator |

65:1 ratio pump packages

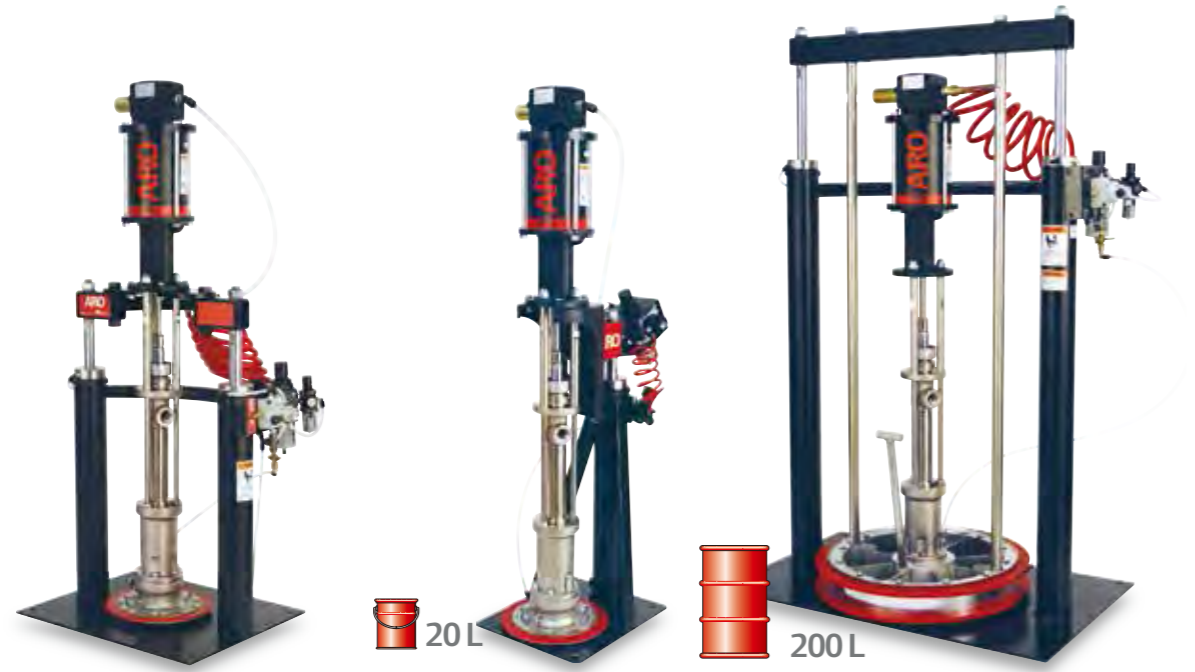

| Model | Type | Pump model | RAM model | Follower plate (model, seal and material) | | Weight | |
|------------------|------------------------|---------------|-----------|---|-----------------------------------|----------|-----------------------------|
| SPD665S21FF47A72 | 20 L / single-post RAM | AF0665S11FF47 | RM051S-C | 67347-2 | Single-tube / EPR | 78.4 kg | |
| SP0665S21FF47A82 | | | | 67347-1 | Single-tube / Neoprene | | Aluminum |
| SPD665S21FF47E32 | | | | 67342-1 | Single lip, polyurethane/urethane | | Carbon steel, nickel plated |
| SP0665S21FF47EA2 | | | | 66732-1 | Double lip / polyurethane | | |
| TP0665S21FF47A72 | 20 L / two-post RAM | AF0665S11FF47 | RM052S-C | 67347-2 | Single-tube / EPR | 111.9 kg | |
| TPD665S21FF47A82 | | | | 67347-1 | Single-tube / Neoprene | | Aluminum |
| TP0665S21FF47E32 | | | | 67342-1 | Single lip, polyurethane/urethane | | Carbon steel, nickel plated |
| TPD665S21FF47EA2 | | | | 66732-1 | Double lip / polyurethane | | |
| TP0665S51FF47AA2 | 200 L / two-post RAM | AF0623S11FF47 | RM552S-C | 66516-1 | Double lip / polyurethane | 190.3 kg | |
| TP0665S51FF47AC2 | | | | 66516 | Double lip / nitrile | | Aluminum |
| TP0665S51FF47AM2 | | | | 67195-1 | Double-tube / Neoprene | | |
| TP0665S51FF47AN2 | | | | 67195-2 | Double-tube / EPR | | |
| TP0665S51GF47AN2 | | | | 67195-2 | | | |

| Pump package accessories | | | |
|--------------------------|--|--|---|
| 66354-1 | 67482 (20 L / 1 post RAM) 67480 (20 L / 2 post RAM) 67481 (200 L / 2 post RAM) | 67502 (20 L / 1 post RAM) 67500 (20 L / 2 post RAM) 67501 (200 L / 2 post RAM) | 637465 (20 L / 1 post RAM) 637466 (20 L / 2 post RAM) 637472 (200 L / 2 post RAM) |
| Pump stabilizing bracket | Cross over kit | Low-level cut-off kit | RAM repair kit |

65:1
22.9 l/min

AFX Series

Chop check extrusion pump

| Specifications | | | |
|----------------|------------------|--------------|------------------------------|
| Ratio | 65:1 | Max. bar | 135 - 400 bar |
| Motor | 12" (305 mm) | Cycle/min. | 70 cycles/min. |
| Motor | 6" (152 mm) | 1 min. | 22.9 l/min. @ 70 cycles/min. |
| AIR | 3/4" NPT(F) | 1 cycle | 328 cc |
| Max. bar | 2.1 - 6.2 bar | For 1 litre | 3 cycles |
| Headphones | 93 dBA @ 4.1 bar | Flange mount | |
| Weight | 74.8 kg | | 1 1/4" NPT(F) |

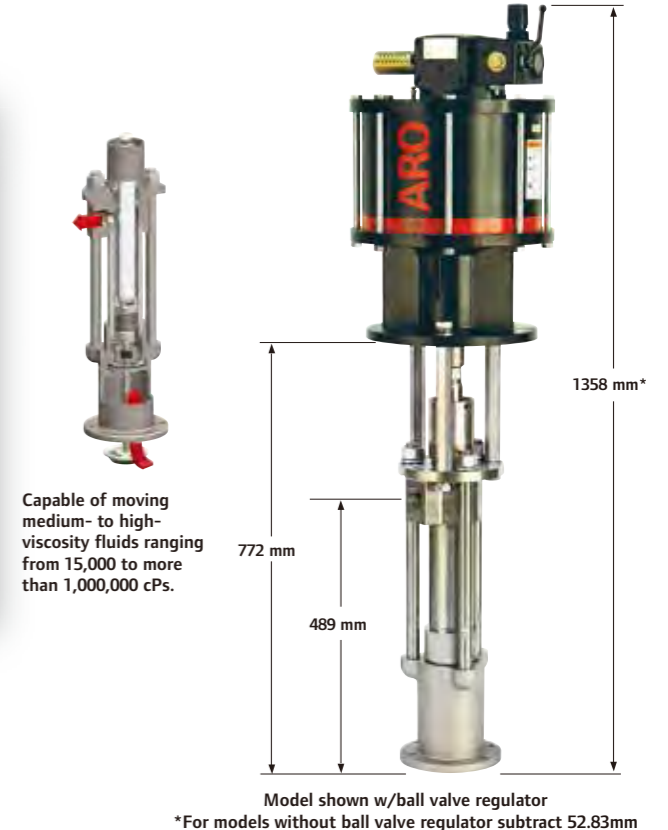

| Pump model no. (1) | Lower pump | Plunger material | Packings (upper + lower) | ServiceKit (2) | |
|--------------------|------------|-----------------------------|------------------------------------|------------------------|------------|
| AF1265S11PF17 | 67300-J3D | Carbon steel, nickel plated | 17-4 stainless steel / hard chrome | Polyurethane + UHMW-PE | 637348-J3D |
| AF1265S11FF47 | 67300-C4D | | | UHMW-PE + UHMW-PE | 637348-C4D |

(1) Add "-1" to Model No. for Ball Valve Regulator
(2) Lower pump repair kit

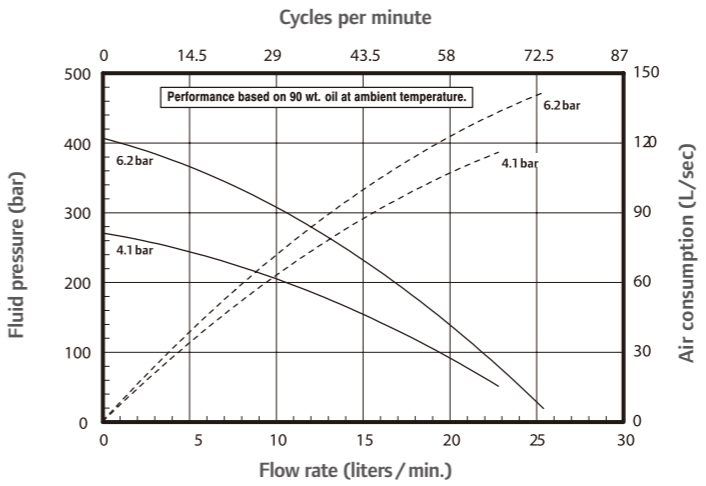

| Pump accessories | | |
|------------------|-----------------------------|--|
| 67445-5 | High performance muffler | |
| 635043 | AroStop valve | |
| 65139 | Floor mount | |
| 637489 | Universal motor service kit | |
| 67442 | Ball Valve Regulator | |

65:1 ratio pump packages



| Model | Type | Pump model | RAM model | Follower plate (model, seal and material) | | Weight |
|------------------|--------------------------------|---------------|-----------|---|------------------------------------|----------|
| SCS052CCB1265A8 | 20 L / two-post RAM | AF1265S11PF17 | - | 47520421001 | Single-tube / Neoprene Aluminum | 150 kg |
| TP1265S51PF17AA2 | 200 L / two-post RAM | AF1265S11PF17 | RMS52S-C | 66517-1 | Double lip / polyurethane Aluminum | 211.6 kg |
| TP1265S51FF47AN2 | | AF1265S11FF47 | | 67196-2 | Double-tube / EPR Aluminum | |
| TPD265S51PF17AM2 | | AF1265S11PF17 | | 67196-2 | Double-tube / EPR Aluminum | |
| TPD265S51PF17AM2 | | AF1265S11PF17 | | 67196-1 | Double tube / Neoprene Aluminum | |
| HDD265S51PF17AN2 | 200L / heavy-duty two-post RAM | AF1265S11PF17 | RMS52H-C | 67196-2 | Double tube / Neoprene Aluminum | 260 kg |
| HDD265S51PF17AM2 | | AF1265S11PF17 | | 67196-1 | Double tube / Neoprene Aluminum | |

| Model | Type | Lower pump material | Packings (upper + lower) | Follower plate (model, seal and material) | Weight |
|-----------------|---------------------|----------------------------|--------------------------|---|----------|
| SCS552CSA1265TN | 200L / two-post RAM | 300 Series stainless steel | UHMW-PE + UHMW-PE | Double tube / EPR Aluminum / PTFE coating | 265.0 kg |



66353-1



67481

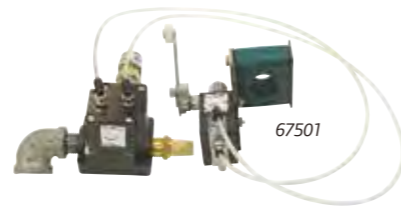

67501

| Pump package accessories | | | |
|--------------------------|----------------|-----------------------|-------------------------------|
| 66353-1 | 67481 | 67501 | 637472 |
| Pump stabilizing bracket | Cross over kit | Low-level cut-off kit | 200 L two-post RAM repair kit |



66334-B

66333-B
WetSol, pump upper packing lubricant - 1 liter

66334-B
WetSol, pump upper packing lubricant - 3.8 liters

Recommended for use in piston pumps solvent cups – Increase the performance and service life of pumping equipment.



Accessories

Piston pumps accessories

The ARO accessories will improve the efficiency of your extrusion application. They include RAMs, follower plates, pressure regulators, etc. The illustrations presented on this page will enable you to select the equipment which will supplement your pump. Use only genuine ARO accessories and replacement parts to assure compatible pressure rating, longest service life possible and the best results in your operation.

2

RAMs: Function like a lift, but also exert downward force. Ram air cylinders push pump and follower plate into the fluid. Available in single or two-post configurations, for 20 L or 200 L containers. Used on medium to high viscosity fluids.

3

Follower Plates: Plates mount directly to pump inlet. Fluid is assisted into pump. Available for 20 litres pails and 200 litres drums.



Typical airless spray system.

1

Air filter and regulator

4

Follower Seals: Forms seal between follower plate and container to maintain prime. Available in single or double lip models. Use single-lip wiper for viscosities up to 300,000 cP. Double lip wiper provides better wiping action on higher viscosity fluids. Use double-lip wipers for fluids viscosities over 300,000 cP.

5

Material filter

6

Material heater

7

Downstream Fluid Regulators: Used to control fluid pressure at the dispense point. Downstream regulators cut fluid pressure to desired level. Also used to eliminate pulsation to provide even consistent flow of material.

8

Extrusion Guns: Used to dispense fluids with viscosities above 200,000 cPs. Available in manual or automatic configurations. "Snuff-back" guns eliminate drippage at work site.

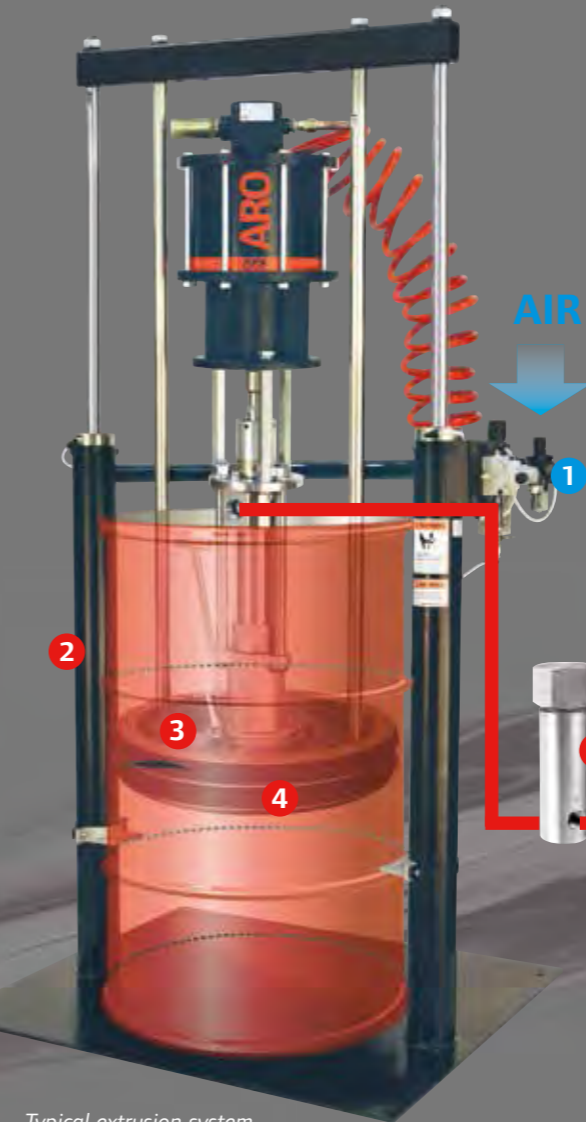

Typical extrusion system

Floor Mounts: Used when fluid is stored in large, bulk containers. Gravity feeds material into the pump inlet. Locate as close to fluid container as possible.

Lifts

When fluids are too viscous to flow easily, extra steps are needed to keep a pump primed. That's where a lift or ram comes into play. Lifts are used to mount the pump above the fluid container. The weight of the pump and mounting bracket forces the pump into the fluid to keep it primed. An internal cylinder then lifts the pump from an empty container.

Portable Lifts



| Model | Description | Usage Parameters | Dimensions |
|------------------|--|---|--|
| 67075-X-B | Portable Lift For use with 5-gallon pails containing fluids with viscosities up to 200,000 cPs. A needle valve allows the operator to control the speed at which the pump is raised and lowered. | <ul style="list-style-type: none"> 67075-B is used with the CL0443S21GN47E32, CL0443T21GN47S31, and NP322LOX-X models 67075-1-B is used with the CL0409A91LL2DE31, CL0409A91LL2DE3B | Base: 26-19/32" (675.5 mm) x 27-1/2" (698.5 mm) Height: 42-59/64" (1090.2 mm) lowered |

Stationary Lifts



| Model | Description | Used With | Dimensions |
|---------------|---|--|---|
| 640169 | Two-Post Lift For use with 5-gallon and 55-gallon drums. Features two 2" (50.8 mm) diameter cylinders connected by a mounting bracket. Lift cylinders are bolted to floor. | <ul style="list-style-type: none"> 4-1/4" and 6" air motor 2-ball, 4-ball and chop-check pumps 66469 single-lip follower plate for 5-gallon drums 66248 single-lip follower plate for 55-gallon drums | Height (lowered): 55-1/2" (1409.7 mm) Height (raised): 92-1/4" (2343.1 mm) |
| 640067 | Single-Post Lift For use with 55-gallon drums. Lift is bolted to floor. Support arms attach to drum cover. Lift is used to raise drum cover and bung-mounted pump. Use when pumping grease, oil and low-viscosity fluids. | <ul style="list-style-type: none"> All 55-gallon bung-type pumps 651852 or 66197 drum covers | Height (lowered): 55-1/2" (1409.7 mm) Height (raised): 92" (2336.8 mm) |

Floor Mounts/Portable Carts



| Model | Description | Used With |
|----------------|--|---|
| 67187-1 | Mounting Post Floor stand mounting post with 4-1/4", 6", and 8" air motors | 4-1/4", 6" and 8" Stinger 4-ball pumps |
| 66554-1 | Portable Cart 24" to 30" wheel spacing adjustment; has 16" tires | 4-1/4" and 6" Integrity 2-ball pumps |
| 66554-2 | Portable Cart 24" to 30" wheel spacing adjustment; has 16" tires | 8", 10" and 12" air motor 2-ball pumps 8" air motor Integrity 2-ball pumps |
| 67139 | Portable Cart Will clear 28" openings Unique chair design distributes pump weight and makes moving easy 12" (305 mm) pneumatic tires also enhance smooth transport | 4-1/4" and 6" Integrity 2-ball pumps |

RAM & follower plate for 200 L container

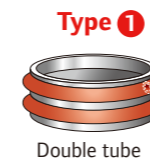

Standard RAM

For use with materials over 200,000 cPs viscosity. Consists of two 89 mm diameter air cylinders joined by cross-over tubes and welded to a steel base. Cast aluminum follower plate has double edge or double tube wiper to clean drum and seal material from atmosphere.

Base 991 mm x 610 mm
 Raised height 2.5 m
 Lowered position height 1.6 m

Mounting

Mounting footprint is strictly a reference letter used to simplify the matching of pumps to follower plates and related accessories. (i.e. pump with "A" mounting footprint will fit any accessory with "A" mounting footprint).

| Model no. | Follower plate | Mounting | Coating | Wiper type | Wiper material |
|---------------|----------------|----------|---------|------------|----------------|
| RM552S-CAA-AC | 66516 | A | — | Type 2 | Nitrile |
| RM552S-CAA-AA | 66516-1 | A | — | Type 2 | Polyurethane |
| RM552S-CAA-AB | 66516-2 | A | — | Type 2 | EPR |
| RM552S-CAB-AC | 66517 | B | — | Type 2 | Nitrile |
| RM552S-CAB-AA | 66517-1 | B | — | Type 2 | Polyurethane |
| RM552S-CAB-AB | 66517-2 | B | — | Type 2 | EPR |
| RM552S-CAA-AN | 67195-2 | A | — | Type 1 | EPR |
| RM552S-CAA-AM | 67195-1 | A | — | Type 1 | Nitrile |
| RM552S-CAA-AV | 67195-3 | A | — | Type 1 | Viton |
| RM552S-CAB-AN | 67196-2 | B | — | Type 1 | EPR |
| RM552S-CAB-AM | 67196-1 | B | — | Type 1 | Nitrile |
| RM552S-CAB-AV | 67196-3 | B | — | Type 1 | Viton |
| RM552S-CAA-TA | 66516-6 | A | PTFE | Type 2 | Polyurethane |
| RM552S-CAA-TB | 66516-7 | A | PTFE | Type 2 | EPR |
| RM552S-CAB-TA | 66517-6 | B | PTFE | Type 2 | Polyurethane |
| RM552S-CAA-TN | 67195-6 | A | PTFE | Type 1 | EPR |
| RM552S-CAA-TM | 67195-5 | A | PTFE | Type 1 | Nitrile |
| RM552S-CAA-TV | 67195-7 | A | PTFE | Type 1 | Viton |
| RM552S-CAB-TN | 67196-6 | B | PTFE | Type 1 | EPR |
| RM552S-CAB-TV | 67196-7 | B | PTFE | Type 1 | Viton |

Pump / Drum stabilizing brackets for RM552X-XXX-XX.



66354-1



67503

| Model | Description | For use with: |
|---------|--|---------------------------------|
| 66353-1 | Pump Stabilizing Brackets – Attaches easily to RM552X-XXX-XX Ram. Kit includes hardware. | 8", 10" and 12" air motor pumps |
| 66354-1 | Pump Stabilizing Brackets – Same as 66353-1 except fits smaller pumps. | 4 1/2" and 6" air motor pumps |
| 67503 | Drum Hold-Down Brackets - Kit includes 2 brackets, clamp screws, nuts. | RM552S-XXX-XX |
| 67504 | Drum Hold-Down Brackets - Kit includes 2 brackets, clamp screws, nuts. | RM552H-XXX-XX |

Extra Heavy-Duty RAM

Features 5 1/2" dia. post construction capable of delivering 0 - 8 bar* follower down force. This extra measure of down force makes the RM552H-XXX-XX RAM the best choice for the hard-duty supply of heavy inks, RTV silicones, caulking, varnishes, highly viscous adhesives and much more. Drum hold down bracket included.

*WARNING: Before using maximum follower down force, check container or consult container manufacturer for maximum pressure rating.



| Model no. | Follower plate | Mounting | Coating | Wiper type | Wiper material |
|---------------|----------------|----------|---------|------------|----------------|
| RM552H-CAA-AC | 66516 | A | — | Type 2 | Nitrile |
| RM552H-CAA-AA | 66516-1 | A | — | Type 2 | Polyurethane |
| RM552H-CAA-AB | 66516-2 | A | — | Type 2 | EPR |
| RM552H-CAB-AC | 66517 | B | — | Type 2 | Nitrile |
| RM552H-CAB-AA | 66517-1 | B | — | Type 2 | Polyurethane |
| RM552H-CAB-AB | 66517-2 | B | — | Type 2 | EPR |
| RM552H-CAA-AN | 67195-2 | A | — | Type 1 | EPR |
| RM552H-CAB-AN | 67196-2 | B | — | Type 1 | EPR |
| RM552H-CAB-AM | 67196-1 | B | — | Type 1 | Nitrile |

Follower plates for 200 L container

Mounting

Mounting footprint is strictly a reference letter used to simplify the matching of pumps to follower plates and related accessories. (i.e. pump with "A" mounting footprint will fit any accessory with "A" mounting footprint).



| Model no. | Material | Coating | Wiper material | Used with RAM models: | Mounting |
|-------------------------|--------------|---------|------------------------------|-----------------------|----------|
| Single lip wiper | | | | | |
| 66248 | Carbon Steel | — | Nitrile, Polyethylene backup | 640169 | A |
| 66248-1 | Carbon Steel | — | Polyethylene | 640169 | A |
| Double lip wiper | | | | | |
| 66516 | Aluminium | — | Nitrile | RM552X-XXX-XX | A |
| 66516-1 | Aluminium | — | Polyurethane | RM552X-XXX-XX | A |
| 66516-2 | Aluminium | — | EPR | RM552X-XXX-XX | A |
| 66516-5 | Aluminum | PTFE | Nitrile | RM552X-XXX-XX | A |
| 66516-6 | Aluminum | PTFE | Polyurethane | RM552X-XXX-XX | A |
| 66516-7 | Aluminum | PTFE | EPR | RM552X-XXX-XX | A |
| 66517 | Aluminum | PTFE | Nitrile | RM552X-XXX-XX | B |
| 66517-1 | Aluminum | PTFE | Polyurethane | RM552X-XXX-XX | B |
| 66517-2 | Aluminum | PTFE | EPR | RM552X-XXX-XX | B |
| 66517-5 | Aluminum | PTFE | Nitrile | RM552X-XXX-XX | B |
| 66517-6 | Aluminum | PTFE | Polyurethane | RM552X-XXX-XX | B |
| 66517-7 | Aluminum | PTFE | EPR | RM552X-XXX-XX | B |
| Tube type wiper | | | | | |
| 67195-1 | Aluminium | — | Neoprene | RM552X-XXX-XX | A |
| 67195-2 | Aluminium | — | EPR | RM552X-XXX-XX | A |
| 67195-3 | Aluminium | — | Viton | RM552X-XXX-XX | A |
| 67195-5 | Aluminum | PTFE | Neoprene | RM552X-XXX-XX | A |
| 67195-6 | Aluminum | PTFE | EPR | RM552X-XXX-XX | A |
| 67195-7 | Aluminum | PTFE | Viton | RM552X-XXX-XX | A |
| 67196-1 | Aluminum | — | Nitrile | RM552X-XXX-XX | B |
| 67196-2 | Aluminum | — | EPR | RM552X-XXX-XX | B |
| 67196-3 | Aluminum | — | Viton | RM552X-XXX-XX | B |
| 67196-5 | Aluminum | PTFE | Nitrile | RM552X-XXX-XX | B |
| 67196-6 | Aluminum | PTFE | EPR | RM552X-XXX-XX | B |
| 67196-7 | Aluminum | PTFE | Viton | RM552X-XXX-XX | B |

Seal Protectors

Package of 10 for 200 liters followers to be inserted between the follower plate and the material in the container. This helps to prevent corrosive materials from attacking the wiper and reduces clean-up time.

Model no. 91363-10

RAM & follower plate for 20 L container

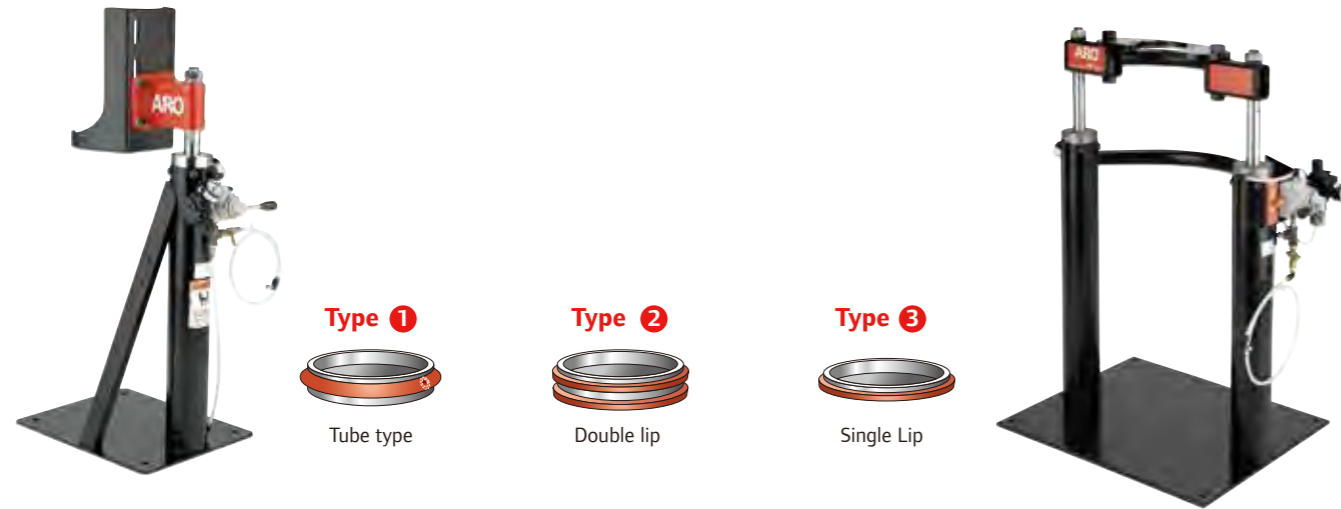

Standard RAM

For use with materials lower 1,000,000 cPs viscosity.
Consists of a 3-1/4" (89 mm) diameter air cylinder, accommodate standard 20 liter containers.

Base: 432 mm x 356 mm
Raised height: 1.33 m (RM051S-CXX-XX)
1.28 m (RM051S-BXX-XX)
Lowered position height: 0.89 m (RM051S-CXX-XX)
0.84 m (RM051S-BXX-XX)

Standard RAM

For use with materials over 200,000 cPs viscosity.
Consists of two 3-1/4" (89 mm) diameter air cylinders joined by cross-over tubes and welded to a steel base.

Base: 610 mm x 502 mm
Raised height: 1.36 m
Lowered position height: 0.90 m

| Model no. | Follower plate | Mounting | Coating | Wiper type | Wiper material |
|---------------------------------------|----------------|----------|--------------------|------------|-----------------------|
| RM051S-C (RM051S-C-GL) ⁽¹⁾ | — | — | — | — | — |
| RM051S-B ⁽¹⁾ | — | — | — | — | — |
| RM051S-CAA-A7 | 67347-2 | A | — | Type 1 | EPR |
| RM051S-CAA-A8 | 67347-1 | A | — | Type 1 | Nitrile |
| RM051S-CAA-E3 | 67342-1 | A | Electroless Nickel | Type 3 | Polyethylene/Urethane |
| RM051S-CAA-EA | 66732-1 | A | Electroless Nickel | Type 2 | Polyurethane |
| RM051S-CAA-EC | 66732 | A | Electroless Nickel | Type 2 | Nitrile |
| RM051S-CAC-E3 | 651840-1 | C | Electroless Nickel | Type 3 | Polyethylene/Urethane |
| RM051S-CAC-E5 | 65840-3 | C | Electroless Nickel | Type 3 | Nitrile/Polyethylene |
| RM051S-CAC-S3 | 651841-1 | C | Stainless Steel | Type 3 | Polyethylene/Urethane |

| Model no. | Follower plate | Mounting | Coating | Wiper type | Wiper material |
|-------------------------|----------------|----------|--------------------|------------|-----------------------|
| RM052S-C ⁽¹⁾ | — | — | — | — | — |
| RM052S-B ⁽¹⁾ | — | — | — | — | — |
| RM052S-CAA-A7 | 67347-2 | A | — | Type 1 | EPR |
| RM052S-CAA-A8 | 67347-1 | A | — | Type 1 | Nitrile |
| RM052S-CAA-E3 | 67342-1 | A | Electroless Nickel | Type 3 | Polyethylene/Urethane |
| RM052S-CAA-EA | 66732-1 | A | Electroless Nickel | Type 2 | Polyurethane |
| RM052S-CBC-E3 | 651840-1 | C | Electroless Nickel | Type 3 | Polyethylene/Urethane |
| RM052S-CBC-E5 | 65840-3 | C | Electroless Nickel | Type 3 | Nitrile /Polyethylene |
| RM052S-CBC-S3 | 651841-1 | C | Stainless Steel | Type 3 | Polyethylene/Urethane |
| RM052S-CCA-A7 | 67347-2 | A | — | Type 1 | EPR |
| RM052S-CEA-E3 | 651840-1 | A | Electroless Nickel | Type 3 | Polyethylene/Urethane |

(1) RM052S-B = basic model — RM052S-C = RAM with airline equipment.

RAM & follower plate for 20 L / 30 L / 60 L container



Standard RAM

The ARO model RM072 two post lift / RAM uses two 3 1/4" (Ø 89 mm) air powered cylinders connected by a steel cross member and welded to a heavy gauge base plate. It is normally used to raise and lower a fluid handling pump and follower in and out of a standard 20 liter drum, or when used as a RAM, it can force high viscosity flowable material into the pump inlet.

Base 502 mm x 610 mm
Raised height 1.87 m
Lowered position height 1.1 m.

Mounting

Mounting footprint is strictly a reference letter used to simplify the matching of pumps to follower plates and related accessories. (i.e. pump with "A" mounting footprint will fit any accessory with "A" mounting footprint).

| Model no. | Follower plate | Mounting | Coating | Wiper type | Wiper material |
|-------------------------|----------------|----------|--------------------|------------|-----------------------|
| RM072S-B ⁽¹⁾ | — | — | — | — | — |
| RM072S-C ⁽¹⁾ | — | — | — | — | — |
| RM072S-CAA-A7 | 67347-2 | A | — | Type 1 | EPR |
| RM072S-CAA-A8 | 67347-1 | A | — | Type 1 | Neoprene |
| RM072S-CAA-E3 | 67342-1 | A | Electroless Nickel | Type 3 | Polyethylene urethane |
| RM072S-CAA-EA | 66732-1 | A | Electroless Nickel | Type 2 | Polyurethane |
| RM072S-CBC-E3 | 651840-1 | C | Electroless Nickel | Type 3 | Polyethylene urethane |
| RM072S-CBC-E5 | 651840-3 | C | Electroless Nickel | Type 3 | Polyethylene urethane |
| RM072S-CBC-S3 | 651841-1 | C | Stainless Steel | Type 3 | Polyethylene urethane |
| RM072S-CCA-A7 | 67347-2 | A | — | Type 1 | Neoprene |
| RM072S-CDD-S3 | 651842-1 | D | Stainless Steel | Type 3 | Polyethylene urethane |
| RM072S-CEA-E3 | 67342-1 | A | Electroless Nickel | Type 3 | Polyethylene urethane |

(1) RM072S-B = basic model — RM072S-C = RAM with airline equipment.

Followers plates for 20 L container

Mounting

Mounting footprint is strictly a reference letter used to simplify the matching of pumps to follower plates and related accessories. (i.e. pump with "A" mounting footprint will fit any accessory with "A" mounting footprint).



| Model no. | Material | Coating | Wiper material | Used with RAM models : | Mounting |
|-------------------------|--------------|--------------------|-----------------------|---|----------|
| Single lip wiper | | | | | |
| 66469 | Carbon Steel | — | Nitrile | 67075-X-B, RM051S-XXX-XX, RM052S-XXX-XX, RM072S-XXX-XX, RM552S-XXX-XX | A |
| 67342-2 | Carbon Steel | Electroless Nickel | Nitrile | RM051S-XXX-XX, RM052S-XXX-XX, RM072S-XXX-XX | A |
| 67342-1 | Carbon Steel | Electroless Nickel | Polyethylene urethane | RM051S-XXX-XX, RM052S-XXX-XX, RM072S-XXX-XX | A |
| Double lip wiper | | | | | |
| 66731-1 | Carbon Steel | Electroless Nickel | Polyurethane | RM051S-XXX-XX, RM052S-XXX-XX, RM072S-XXX-XX | C |
| 66731-2 | Carbon Steel | Electroless Nickel | EPR | RM051S-XXX-XX, RM052S-XXX-XX, RM072S-XXX-XX | C |
| 66732 | Carbon Steel | Electroless Nickel | Nitrile | RM051S-XXX-XX, RM052S-XXX-XX, RM072S-XXX-XX | A |
| 66732-1 | Carbon Steel | Electroless Nickel | Polyurethane | RM051S-XXX-XX, RM052S-XXX-XX, RM072S-XXX-XX | A |
| 66732-2 | Carbon Steel | Electroless Nickel | EPR | RM051S-XXX-XX, RM052S-XXX-XX, RM072S-XXX-XX | A |
| Tube type wiper | | | | | |
| 67347-1 | Aluminium | — | Neoprene | RM051S-XXX-XX, RM052S-XXX-XX, RM072S-XXX-XX | A |
| 67347-2 | Aluminium | — | EPR | RM051S-XXX-XX, RM052S-XXX-XX, RM072S-XXX-XX | A |
| 67347-11 | Aluminum | PTFE | Neoprene | RM051S-XXX-XX, RM052S-XXX-XX, RM072S-XXX-XX | A |
| 67347-12 | Aluminum | PTFE | EPR | RM051S-XXX-XX, RM052S-XXX-XX, RM072S-XXX-XX | A |

| Model no. | Diameter | Material | Coating | Wiper material | Used with RAM models: | Mounting |
|----------------------------------|----------|-----------------|---------|-----------------------|-----------------------|----------|
| Designed for metric pails | | | | | | |
| 651840-1 | 290 mm | Carbon Steel | — | Polyethylene urethane | 67075 65778 | C |
| 651840-2 | 295 mm | Carbon Steel | — | Nitrile | 67075 65778 | C |
| 651840-3 | 311.9 mm | Carbon Steel | — | Polyethylene urethane | 67075 65778 | C |
| 651841-1 | 290 mm | Stainless Steel | — | Polyethylene urethane | 67075 65778 | C |
| 651842-1 | 290 mm | Stainless Steel | — | Polyethylene urethane | — | D |

Seal Protectors

Package of 10 for 20 liters followers to be inserted between the follower plate and the material in the container. This helps to prevent corrosive materials from attacking the wiper and reduces clean-up time.

Model no. 91364-10

Floor mounts, adapters, siphon tubes

Floor mounts

Accepts suction line from bulk containers or mixing tanks. 3" NPT(F) inlet. 1/4" NPT(F) vent port with plug. footprint.

| Model | For use with: | Mounting |
|--------|--|----------|
| V65138 | 4 1/4" & 6" air motor, 2-ball and extrusion pumps. Also 8" 40:1 2-ball and 44:1 extrusion pumps. | A |
| 65139 | 8", 10" and 12" air motor 2-ball and extrusion pumps. | B |

Follower plate adapter

67134 For attaching NM2322X-X and AF0443X21GN47 pumps to 200 L follower plates or floor stands

67136 For attaching Integrity pumps to follower plates or floor stand. Includes stainless steel adapter w/2" NPT(F) threads, seal and hardware.

| Model | For use with: | Mounting |
|-------|--|----------|
| 67134 | 66516-X & 6719X-X Followers – RM552S-XXX-XX, RM552H-XXX-XX Rams – 65138 Floor Mount. | A |
| 67136 | 66248 & 66516 Followers – RM051S-XXX-XX, RM052S-XXX-XX, RM072S-XXX-XX, RM552S-XXX-XX Rams – 65138 Floor Mount. | A |

Wall mount brackets for oil pumps

| Model | Description | For use with pumps: |
|-------|---|--|
| 61113 | 2" NPTF opening for bung-type pumps. Bracket can slip over rim of open-head drum or be wall-mounted. | LM2203A-1X-C, LM2305A-1X-B, 612041-1 & 612041-3, 612042-1, AF0409A13PFL1 (with additional, 60870 bung adapter) |
| 66100 | Wall-mount bracket has removable mounting plate. | AF0409AX3PFL1 |
| 66101 | Wall-Mount Bracket • With 91396 removable mounting plate | • 4-1/4" and 6" air motor 2-ball and 4-ball pumps; including Integrity and Stinger models |
| 66542 | Wall-Mount Bracket • With 92371 removable mounting plate | • 8", 10" and 12" air motor 2-ball pumps • 8" air motor Stinger 4-ball pumps |
| 76763 | Wall-Mount • Open front permits easy installation of pump • Can be bolted to wall at back or side of bracket | • All "N" Series and 1/2" diaphragm pumps |

2" male tread bung adapters

| Model | For use with pumps: | | | | | |
|-------------------------|---------------------|---------------|---------------|---------------|---------------|---------------|
| For oil pumps | | | | | | |
| 60870 | 612041-1 | 612041-3 | 612042-1 | AF0409A13PFL1 | AF0409A43PFL1 | AF0409A53PFL1 |
| 67145-3-B | LM2203A-X2-C | LM2203A-X1-C | | | | |
| 67145-4-B | LM2305A-X2-B | LM2305A-X1-B | | | | |
| For Grease pumps | | | | | | |
| 4148 | AF0450L23PKL1 | AF0450L43PKL1 | AF0450L53PKL1 | AF060BL43PKL1 | AF060BL53PKL1 | |
| 67145-2 | LM2250E-XX-B | LM2350E-XX-B | | | | |

Bung adapter seal kit

| Model | Description | For use with: |
|-------|-----------------------------------|-----------------|
| 67088 | Water-tight seal for use outdoor. | LM series pumps |

Drum Covers

| Model | Description | For use with pumps: | Container Size |
|--------|--|--|----------------|
| 66971 | Drum Cover • Stainless steel, accepts 651100 agitator | • 1/2" ports diaphragm pump | 5 gallon |
| 66197 | Drum Cover • Includes hinged access covers, 2" NPT(F) bung opening, and will accept 651104-1 agitator • Carbon steel | • 2", 3" and 4-1/4" 55-gal bung-type pumps | 55 gallon |
| 651852 | Drum Cover • Includes hinged access covers, 2" NPT(F) bung opening, 2" x 34" pipe extension and 60307-1 agitator • Carbon steel | • Accepts 65986-1 siphon hose from any wall-mounted pump; any 55-gallon bung-type pump that can be used with 640067 lift | 55 gallon |



65138



67136



61113

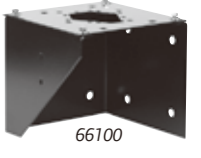

66100

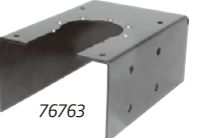

76763



67145-X



67145-X-B



66197



651852

Siphon Hoses



67140-1



65986

| Model | Description | For use with pumps: | Hose |
|-----------------|--|---|--|
| 65986 | Siphon Hose • 55-gallon size; neoprene cover and thiokol tube • Includes 91020-2 pipe extension | • Wall-mounted stub pumps | • 6' length, 3/4" (M) fluid outlet |
| 65986-1 | Siphon Hose • 55-gallon size; neoprene cover and thiokol tube • Includes 91020-2 pipe extension | • 651852 drum cover or closed drum with 2" bung opening | • 6' length, 3/4" (M) fluid outlet |
| 622702-6 | Siphon Hose • 1" I.D. hose with stainless steel fittings | • Stainless steel stub pumps | • 6' length, 1" (M) fluid outlet, 1" (M) fluid inlet |
| 622701-6 | Siphon Hose • 1" I.D. hose with carbon steel fittings | • Carbon steel stub pumps | • 6' length, 1" (M) fluid outlet, 1" (M) fluid inlet |
| 67140-1 | Stainless Steel Siphon hose • For 5-gallon containers; includes 16" wand and 5' of 3/4" I.D. hose | • Wall-mounted Integrity pumps | • 5' length, 3/4" (M) fluid outlet |
| 67140-2 | Stainless Steel Siphon hose • For 55-gallon containers; includes 36" wand and 5' of 3/4" I.D. hose | • Wall-mounted Integrity pumps | • 5' length, 3/4" (M) fluid outlet |
| 61601 | Includes 622651-6 hose, Y45-24-C adapter bushing, Y43-5-C street elbow, and 65109 carbon steel suction tube | • Wall-mounted stub pumps | • 6' length, 3/4" (M) fluid inlet and outlet |

Tubes



65109



66568



91020-1

| Model | Description | For use with pumps: | Fluid Outlet |
|----------------|--|--|--------------------------|
| 65109 | Siphon Tube Assembly • 55-gallon size carbon steel with 2" bung adapter; hose not included • Suggest 622681-6 hose for 3/4" inlet or 66701-6 hose for 1" inlet | • Wall-mounted stub pumps when fluid viscosity requires a foot valve for priming or twirl drum cover that has a 2" NPT(F) bung adapter | 3/4" NPT(F) or 1" NPT(F) |
| 66568 | Siphon Tube Assembly with Filter and Check Valve Assembly • 316 stainless steel with 2" NPT bung adapter and 66480 filter and check valve assembly; hose not included • Suggest 622702-6 hose | • Wall-mounted stub pumps when fluid is corrosive and viscosity requires a foot valve for positive priming | 1" NPT(F) |
| 66717 | Pipe Extension • Constructed of PVC for AF0409C11XXXX and NM2304B-X pumps | • 55-gallon containers | — |
| 91020-1 | Pipe Extension • 1/2" I.D. galvanized suction tube | • 5-gallon containers | — |
| 91020-2 | Pipe Extension • 1/2" I.D. galvanized suction tube | • 55-gallon containers | — |
| 61409 | 90° PVC siphon tube, 35-1/2" long with 2" bung adapter for 55-gallon drums. Can easily be cut to desired length, on site. | • 55-gallon containers • stub pumps | 1/2" NPT(F) |
| 66779 | PVC tube has foot valve for positive priming. Includes 76193 bung adapter, adjustable to approximately 35-1/2" | • 55-gallon containers • stub pumps | 1" NPT(F) |
| 66779-2 | PVC tube has foot valve for positive priming. Includes 76193 bung adapter, adjustable to approximately 48-1/4" | • 275-gallon tanks stub pumps | 1" NPT(F) |

High-pressure Hose

In selecting a hose, be sure the hose material is compatible with the fluid being pumped and that the maximum working pressure will not be exceeded in the application.

Only those hose length options listed with each model are available.

Substitute -XX with -5, -15, -25, etc., to indicate length selection.

(Example: Substitute -XX with length selection, such as -50. If length is single digit, use that digit only. Do not add zeros.)

***CAUTION: These hoses cannot be used with 100:1 ratio pumps.**

Never use a hose with a maximum pressure rating lower than the highest pressure the pump can generate.

| Model | ID in (mm) | OD in (mm) | Fitting threads both ends in | Max pressure psi (bar) | Length ft (m) |
|--|-------------|---------------|------------------------------|------------------------|---------------|
| BUNA-N TUBE, NEOPRENE COVER | | | | | |
| 1-WIRE BRAID | | | | | |
| 623501-2 | 1/2" (12.7) | 29/32" (23.0) | 1/2" NPT (M) | 2,000 (138) | 2' (0.6) |
| 623501-5 | 1/2" (12.7) | 29/32" (23.0) | 1/2" NPT (M) | 2,000 (138) | 5' (1.5) |
| 623501-6 | 1/2" (12.7) | 29/32" (23.0) | 1/2" NPT (M) | 2,000 (138) | 6' (1.8) |
| 623501-8 | 1/2" (12.7) | 29/32" (23.0) | 1/2" NPT (M) | 2,000 (138) | 8' (2.4) |
| 2-WIRE BRAID | | | | | |
| 624201-2 | 1/4" (6.3) | 11/16" (17.5) | 1/8" NPT (F) | 5,000 (345) | 2' (0.6) |
| 624201-6 | 1/4" (6.3) | 11/16" (17.5) | 1/8" NPT (F) | 5,000 (345) | 6' (1.8) |
| 624201-10 | 1/4" (6.3) | 11/16" (17.5) | 1/8" NPT (F) | 5,000 (345) | 10' (3) |
| 624201-30 | 1/4" (6.3) | 11/16" (17.5) | 1/8" NPT (F) | 5,000 (345) | 30' (9.1) |
| 624401-4 | 3/8" (9.5) | 27/32" (21.4) | 3/8" NPT (M) | 4,000 (276) | 4' (1.2) |
| 624401-8 | 3/8" (9.5) | 27/32" (21.4) | 3/8" NPT (M) | 4,000 (276) | 8' (2.4) |
| 624601-4 | 3/4" (19.1) | 1-1/4" (31.7) | 3/4" NPT (M) | 2,250 (155) | 4' (1.2) |
| ELASTOMER TUBE, POLYESTER COVER | | | | | |
| 1-WIRE BRAID | | | | | |
| 628067-3 | 1" (25.4) | 1-1/4" (31.7) | 1" NPT (M) | 800 (55) | 3' (0.9) |

Low-pressure Hose

| Model | ID in (mm) | OD in (mm) | Fitting threads both ends in | Max pressure psi (bar) | Length ft (m) |
|--------------------------------------|-------------|----------------|------------------------------|------------------------|---------------|
| NEOPRENE TUBE, NEOPRENE COVER | | | | | |
| 2-FABRIC BRAID | | | | | |
| 622651-5 | 3/4" (19.1) | 1-3/16" (30.2) | 3/4" NPT (M) | 600 (41) | 5' (1.5) |
| 622651-6 | 3/4" (19.1) | 1-3/16" (30.2) | 3/4" NPT (M) | 600 (41) | 6' (1.8) |
| 622651-10 | 3/4" (19.1) | 1-3/16" (30.2) | 3/4" NPT (M) | 600 (41) | 10' (3) |
| 622651-15 | 3/4" (19.1) | 1-3/16" (30.2) | 3/4" NPT (M) | 600 (41) | 15' (4.6) |
| BUNA-N TUBE, NEOPRENE COVER | | | | | |
| 2-FABRIC BRAID | | | | | |
| 622201-3 | 1/4" (6.3) | 5/8" (15.9) | 1/4" NPT (M) | 250 (17) | 3' (0.9) |
| 622201-5 | 1/4" (6.3) | 5/8" (15.9) | 1/4" NPT (M) | 250 (17) | 5' (1.5) |
| 622201-25 | 1/4" (6.3) | 5/8" (15.9) | 1/4" NPT (M) | 250 (17) | 25' (7.6) |

High pressure fluid regulators

The ARO I.D.L.[®] Fluid Regulator features smooth, consistent pressure regulation with easy-turn adjustment. Patented easy-access seat plug permits immediate service access to the regulator's ball and seat. Patented "floating" ball and seat design maintains proper regulation, even during significant fluctuations in line pressure.

Downstream regulators

| Model no. | Housing base | Seat material | Regulated pressure range | Max. inlet pressure |
|---|-----------------|------------------|--------------------------|---------------------|
| 3/8" ports, flow 11.4 L/min | | | | |
| 651780-A1A-B | Carbon steel | Tungsten carbide | 28 - 86 bar | 207 bar |
| 651780-A1B-B | Carbon steel | Tungsten carbide | 69 - 207 bar | 414 bar |
| 651780-A3A-B | Stainless steel | Tungsten carbide | 28 - 86 bar | 207 bar |
| 651780-A3B-B | Stainless steel | Tungsten carbide | 69 - 207 bar | 414 bar |
| 3/8" ports, flow 22.7 L/min | | | | |
| 651780-B1A-B | Carbon steel | Tungsten carbide | 28 - 86 bar | 207 bar |
| 651780-B1B-B | Carbon steel | Tungsten carbide | 69 - 207 bar | 414 bar |
| 651780-B3A-B | Stainless steel | Tungsten carbide | 28 - 86 bar | 207 bar |
| 651780-B3B-B | Stainless steel | Tungsten carbide | 69 - 207 bar | 414 bar |
| 3/4" ports, flow 75.7 L/min | | | | |
| 651780-C1B-B | Carbon steel | Tungsten carbide | 52 - 172 bar | 414 bar |
| 651780-C1C-B | Carbon steel | Tungsten carbide | 138 - 345 bar | 414 bar |
| 651780-C3B-B | Stainless steel | Tungsten carbide | 52 - 172 bar | 414 bar |
| 3/8" ports, remote models, flow 22.7 L/min | | | | |
| 651780-B1R-B | Carbon steel | Tungsten carbide | 28 - 345 bar | 414 bar |
| 651780-B3R-B | Stainless steel | Tungsten carbide | 28 - 345 bar | 414 bar |
| 3/4" ports, remote models, flow 75.7 L/min | | | | |
| 651780-C1R-B | Carbon steel | Tungsten carbide | 52 - 345 bar | 414 bar |
| 651780-C3R-B | Stainless steel | Tungsten carbide | 52 - 345 bar | 414 bar |

* Flow rates tested in 55 cPs material

Backpressure regulators

| Model no. | Housing base | Seat material | Regulated pressure range | Max. inlet pressure |
|------------------------------------|-----------------|------------------|--------------------------|---------------------|
| 3/8" ports, flow 22.7 L/min | | | | |
| 651781-B1B-B | Carbon steel | Tungsten carbide | 7 - 207 bar | 207 bar |
| 651781-B3B-B | Stainless steel | Tungsten carbide | 7 - 207 bar | 207 bar |
| 3/4" ports, flow 75.7 L/min | | | | |
| 651781-C1B-B | Carbon steel | Tungsten carbide | 7 - 207 bar | 207 bar |
| 651781-C3B-B | Stainless steel | Tungsten carbide | 7 - 207 bar | 207 bar |

* Flow rates tested in 55 cPs material



651780-A1A-B



651780-B3R-B

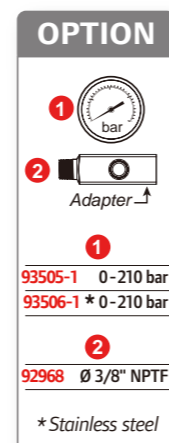

Low pressure fluid regulators

Downstream regulators

| Model no. | Housing base | Seat material | Regul. pressure range | Max. inlet pressure | Gauge pressure |
|--|-----------------|---------------------|-----------------------|---------------------|----------------|
| 3/8" ports, flow 11.4 L/min. Gauge included | | | | | |
| 651790-A1B-B | Zinc aluminium | Tungsten carbide | 0 - 2 bar | 50 bar | 0 - 4 bar |
| 651790-A1C-B | Zinc aluminium | Tungsten carbide | 1.3 - 4 bar | 50 bar | 0 - 4 bar |
| 651790-A1D-B | Zinc aluminium | Tungsten carbide | 3.4 - 14 bar | 50 bar | 0 - 20 bar |
| 651790-A3B-B | Stainless steel | Tungsten carbide | 0 - 2 bar | 50 bar | 0 - 4 bar |
| 651790-A3C-B | Stainless steel | Tungsten carbide | 1.3 - 4 bar | 50 bar | 0 - 4 bar |
| 651790-A3D-B | Stainless steel | Tungsten carbide | 3.4 - 14 bar | 50 bar | 0 - 20 bar |
| 651790-A4B-B | Stainless steel | 300 Stainless steel | 0 - 2 bar | 34 bar | 0 - 4 bar |
| 651790-A4C-B | Stainless steel | 300 Stainless steel | 1.3 - 4 bar | 34 bar | 0 - 4 bar |
| 651790-A4D-B | Stainless steel | 300 Stainless steel | 3.4 - 14 bar | 34 bar | 0 - 20 bar |
| 3/8" ports, flow 22.7 L/min. Gauge included | | | | | |
| 651790-B1D-B | Zinc aluminium | Tungsten carbide | 2 - 14 bar | 86 bar | 0 - 20 bar |
| 651790-B1E-B | Zinc aluminium | Tungsten carbide | 7 - 55 bar | 86 bar | 0 - 70 bar |
| 651790-B3D-B | Stainless steel | Tungsten carbide | 2 - 14 bar | 86 bar | 0 - 20 bar |
| 651790-B3E-B | Stainless steel | Tungsten carbide | 7 - 55 bar | 86 bar | 0 - 70 bar |
| 651790-B4D-B | Stainless steel | 300 Stainless steel | 2 - 14 bar | 34 bar | 0 - 20 bar |
| 3/8" ports, remote models, flow 11.4 L/min | | | | | |
| 651790-A1R-B | Zinc aluminium | Tungsten carbide | 2 - 14 bar | 50 bar | — |
| 651790-A3R-B | Stainless steel | Tungsten carbide | 2 - 14 bar | 50 bar | — |
| 651790-A4R-B | Stainless steel | 300 Stainless steel | 2 - 14 bar | 34 bar | — |
| 3/8" ports, remote models, flow 22.7 L/min | | | | | |
| 651790-B4R-B | Stainless steel | 300 Stainless steel | 2 - 14 bar | 34 bar | — |

* Flow rates tested in 30 wt. oil

Backpressure regulators

| Model no. | Housing base | Seat material | Regul. pressure range | Max. inlet pressure | Gauge pressure |
|--|-----------------|---------------------|-----------------------|---------------------|----------------|
| 3/8" ports, flow 22.7 L/min. Gauge included | | | | | |
| 651791-B1D-B | Zinc aluminium | Tungsten carbide | 0 - 14 bar | 14 bar | 0 - 20 bar |
| 651791-B1E-B | Zinc aluminium | Tungsten carbide | 0 - 55 bar | 55 bar | 0 - 70 bar |
| 651791-B3D-B | Stainless steel | Tungsten carbide | 0 - 14 bar | 14 bar | 0 - 20 bar |
| 651791-B3E-B | Stainless steel | Tungsten carbide | 0 - 55 bar | 55 bar | 0 - 70 bar |
| 651791-B4D-B | Stainless steel | 300 Stainless steel | 0 - 14 bar | 14 bar | 0 - 20 bar |
| 1 1/4" ports, flow 70 L/min. Gauge included | | | | | |
| 651791-C3D-B | Stainless steel | Tungsten carbide | 0 - 14 bar | 14 bar | 0 - 20 bar |
| 651791-C4D-B | Stainless steel | 300 Stainless steel | 0 - 14 bar | 14 bar | 0 - 20 bar |

* Flow rates tested in 55 cPs material

1/4" Ports regulators

| Model no. | Housing base | Seat material | Regul. pressure range | Max. inlet pressure |
|-----------|--------------|------------------|-----------------------|---------------------|
| 27520-400 | Zinc | Tungsten carbide | 0.3 - 2.0 bar | 50 bar |
| 27520-100 | Zinc | Tungsten carbide | 0.3 - 3.4 bar | 50 bar |
| 27520-000 | Zinc | Tungsten carbide | 0.3 - 8.5 bar | 50 bar |
| 27520-200 | Zinc | Tungsten carbide | 0.6 - 17 bar | 50 bar |



651790-A3D-B



651790-A3R-B



651791-B1D-B



27520-200

Extrusion guns

Extrusion nozzles kits and spray tips sold separately (see page 87)

Automatic guns

651511 Flow Gun

Requires 4-way air valve to open and close. Adjusting screw varies stroke length. Aluminum body with tungsten carbide seats.



651511

651513-11-B Flow Gun

Has air open, spring return actuator. Requires 3-way air valve to open. Adjusting screw varies stroke length. 316 stainless steel body with tungsten carbide seat.



661513-11-B

651536-1 Snuff-Back Gun

High flow automatic dispensing gun is designed to handle high-viscosity materials. Requires a 4-way air valve to open and close.



651536-1

651537-1 Flow Gun

Similar to 651511 except with carbon steel body and tungsten carbide ball and seat.

| Model no. | Max. fluid pressure | Fluid inlet | Fluid outlet (ID and thread) | Air pressure - @Fluid pressure |
|-------------|---------------------|---------------|------------------------------|--------------------------------|
| 661511 | 345 bar | 2 x 3/8" NPTF | 6 mm - 11/16" -16(M) | 3.5- 140 bar |
| 661513-11-B | 345 bar | 1/4" NPSM | 2.3 mm - 11/16" -16(M) | 3.5- 140 bar |
| 651536-1 | 345 bar | 2 x 3/8" NPTF | 1/4" NPT (F) | 3.5- 140 bar |
| 651536-2 | 345 bar | 2 x 3/8" NPTF | 3/8" NPT (F) | 3.5- 140 bar |
| 651537-1 | 345 bar | 2 x 3/8" NPTF | 3/8" NPT (M) | 3.5- 140 bar |

Manual guns

651500 Flow Gun

Aluminum body* with tungsten carbide seats.



651533

651533 Flow Gun

Wetted parts are 316 series stainless steel with tungsten carbide seats.

641523-1 Flow Gun

Wetted parts are 300 Series stainless steel with PTFE packings.



651500

| Model no. | Max. fluid pressure | Fluid inlet | Fluid outlet (ID and thread) |
|-----------|---------------------|-------------|------------------------------|
| 651500 | 515 bar | 3/8" NPTF | 6 mm - 11/16" -16(M) |
| 651533 | 345 bar | 1/4" NPSM | 2.3 mm - 11/16" -16(M) |
| 641523-1 | 205 bar | 3/8" NPTF | 6 mm - 1/4" NPT(F) |

* Aluminum is not compatible with halogenated hydrocarbon solvents

Airless spray guns

Automatic guns

651511-1 Spray Gun

Requires 4-way air valve to open and close. Adjusting screw varies stroke length. Secures to 1/2" diameter rod by allen screw. Aluminum body with tungsten carbide seats. Includes 66504 tip guard and nut.



651511-1

651513-12-B Spray Gun

Has air open, spring return cylinder. Requires 3-way air valve to open. Adjusting screw varies stroke length. 316 stainless steel body with tungsten carbide seat. Includes 66504 tip guard and nut.



651513-12-B

| Model no. | Max. fluid pressure | Fluid inlet | Fluid outlet (ID and thread) | Air pressure - @Fluid pressure |
|-------------|---------------------|---------------|------------------------------|--------------------------------|
| 661511-1 | 345 bar | 2 x 3/8" NPTF | 6 mm - 11/16" -16(M) | 3.5- 140 bar |
| 651513-12-B | 345 bar | 1/4" NPSM | 2.3 mm - 11/16" -16(M) | 3.5- 140 bar |

Manual guns

651533 Spray Gun

Wetted parts of stainless steel with tungsten carbide seats. Used to airless spray paints, lacquers, and other light fluids. Includes 66504 tip guard and nut.



651533

651500-1 Spray Gun

Aluminum body* with tungsten carbide seats. Used for airless spraying material over 200,000 cPs. Includes 66504 tip guard and nut.



651500-1

| Model no. | Max. fluid pressure | Fluid inlet | Fluid outlet (ID and thread) |
|-----------|---------------------|-------------|------------------------------|
| 651533 | 345 bar | 1/4" NPSM | 2.3 mm - 11/16" -16(M) |
| 651500-1 | 515 bar | 3/8" NPTF | 6 mm - 11/16" -16(M) |

* Aluminum is not compatible with halogenated hydrocarbon solvents

Extrusion gun nozzles – Airless spray tips

Extrusion gun nozzle kits

76751 Adapter – 1/4" NPTM to 11/16" -16(M) adapts 66541-XX extrusion nozzles to fluid outlet for 641523-1 and 651536-1 flow guns.



66541-XX

TC1850

66541-XX Extrusion nozzle kit

Used on manual or automatic extrusion guns. Hardened steel assembly includes nozzle and cap. 11/16-16 UN(F).

| Model no. | 66541-3 | 66541-4 | 66541-6 | 66541-9 | 66541-12 | 66541-15 | 66541-17 | 66541-18 | 66541-25 | 66541-37 |
|-----------|---------|---------|---------|---------|----------|----------|----------|----------|----------|----------|
| Orifice Ø | 0.8 mm | 1.2 mm | 1.6 mm | 2.4 mm | 3.2 mm | 4.0 mm | 4.4 mm | 4.7 mm | 6.4 mm | 9.5 mm |

Airless spray tips in tungsten carbide

PATTERN WIDTH: This dimension is the nominal pattern width of each tip when tested on a coating material of 20 seconds – No.4 Zahn cup viscosity at 104 bar at a 300 mm distance from the tip.

FLOW RATE in l/min: The flow rates of ARO airless tips are given as l/min on water at pressures shown: Capacities will vary to some degree on other materials.

| Model no. | Orifice Ø | Pattern width | Flow rate (l/min) | | | |
|------------|-----------|---------------|-------------------|--------|---------|---------|
| | | | 35 bar | 69 bar | 103 bar | 138 bar |
| TC540 | 0.005 | 178 | 0.06 | 0.08 | 0.10 | 0.11 |
| TC715 | 0.007 | 76 | 0.11 | 0.15 | 0.19 | 0.23 |
| TC925 (1) | 0.009 | 140 | 0.15 | 0.23 | 0.25 | 0.30 |
| TC950 | 0.009 | 216 | 0.15 | 0.23 | 0.25 | 0.30 |
| TC965 | 0.009 | 254 | 0.15 | 0.23 | 0.25 | 0.30 |
| TC1115 (1) | 0.011 | 76 | 0.23 | 0.30 | 0.38 | 0.46 |
| TC1125 (1) | 0.011 | 140 | 0.23 | 0.30 | 0.38 | 0.46 |
| TC1140 (1) | 0.011 | 178 | 0.23 | 0.30 | 0.38 | 0.46 |
| TC1150 (1) | 0.011 | 216 | 0.23 | 0.30 | 0.38 | 0.46 |
| TC1165 (1) | 0.011 | 254 | 0.23 | 0.30 | 0.38 | 0.46 |
| TC1180 | 0.011 | 292 | 0.23 | 0.30 | 0.38 | 0.46 |
| TC1325 | 0.013 | 140 | 0.34 | 0.46 | 0.57 | 0.68 |
| TC1340 (1) | 0.013 | 203 | 0.34 | 0.46 | 0.57 | 0.68 |
| TC1350 (1) | 0.013 | 229 | 0.34 | 0.46 | 0.57 | 0.68 |
| TC1365 (1) | 0.013 | 227 | 0.34 | 0.46 | 0.57 | 0.68 |
| TC1380 (1) | 0.013 | 330 | 0.34 | 0.46 | 0.57 | 0.68 |
| TC1525 (1) | 0.015 | 152 | 0.46 | 0.61 | 0.38 | 0.87 |
| TC1540 (1) | 0.015 | 208 | 0.46 | 0.61 | 0.38 | 0.87 |
| TC1550 (1) | 0.015 | 254 | 0.46 | 0.61 | 0.38 | 0.87 |
| TC1565 (1) | 0.015 | 305 | 0.46 | 0.61 | 0.38 | 0.87 |
| TC1580 (1) | 0.015 | 356 | 0.46 | 0.61 | 0.38 | 0.87 |
| TC1595 | 0.015 | 394 | 0.46 | 0.61 | 0.38 | 0.87 |
| TC1825 (1) | 0.018 | 152 | 0.68 | 0.95 | 1.14 | 1.37 |
| TC1840 | 0.018 | 216 | 0.68 | 0.95 | 1.14 | 1.37 |
| TC1850 (1) | 0.018 | 254 | 0.68 | 0.95 | 1.14 | 1.37 |
| TC1865 (1) | 0.018 | 330 | 0.68 | 0.95 | 1.14 | 1.37 |
| TC1880 (1) | 0.018 | 381 | 0.68 | 0.95 | 1.14 | 1.37 |
| TC1895 | 0.018 | 432 | 0.68 | 0.95 | 1.14 | 1.37 |
| TC2095 | 0.020 | 457 | 0.76 | 1.06 | 1.33 | 1.52 |

(1) For use with 651555-B Quick Clean only

| Model no. | Orifice Ø | Pattern width | Flow rate (l/min) | | | |
|------------|-----------|---------------|-------------------|--------|---------|---------|
| | | | 35 bar | 69 bar | 103 bar | 138 bar |
| TC2140 (1) | 0.021 | 216 | 0.91 | 1.25 | 1.56 | 1.79 |
| TC2150 (1) | 0.021 | 292 | 0.91 | 1.25 | 1.56 | 1.79 |
| TC2165 (1) | 0.021 | 381 | 0.91 | 1.25 | 1.56 | 1.79 |
| TC2180 (1) | 0.021 | 432 | 0.91 | 1.25 | 1.56 | 1.79 |
| TC2440 (1) | 0.024 | 229 | 1.14 | 1.60 | 1.98 | 2.28 |
| TC2465 | 0.024 | 381 | 1.14 | 1.60 | 1.98 | 2.28 |
| TC2480 | 0.024 | 470 | 1.14 | 1.60 | 1.98 | 2.28 |
| TC2495 | 0.024 | 533 | 1.14 | 1.60 | 1.98 | 2.28 |
| TC2625 | 0.026 | 178 | 1.33 | 1.90 | 2.32 | 2.70 |
| TC2650 (1) | 0.026 | 305 | 1.33 | 1.90 | 2.32 | 2.70 |
| TC2665 (1) | 0.025 | 381 | 1.33 | 1.90 | 2.32 | 2.70 |
| TC2680 (1) | 0.026 | 470 | 1.33 | 1.90 | 2.32 | 2.70 |
| TC2695 | 0.026 | 533 | 1.33 | 1.90 | 2.32 | 2.70 |
| TC2965 (1) | 0.029 | 381 | 1.71 | 2.39 | 3.04 | 3.42 |
| TC2995 | 0.029 | 546 | 1.71 | 2.39 | 3.04 | 3.42 |
| TC3140 (1) | 0.031 | 229 | 2.01 | 2.85 | 3.50 | 4.18 |
| TC3195 | 0.031 | 546 | 2.01 | 2.85 | 3.50 | 4.18 |
| TC3640 (1) | 0.036 | 229 | 2.70 | 3.80 | 4.56 | 5.32 |
| TC3650 | 0.036 | 305 | 2.70 | 3.80 | 4.56 | 5.32 |
| TC3680 | 0.036 | 470 | 2.70 | 3.80 | 4.56 | 5.32 |
| TC4195 | 0.041 | 546 | 3.34 | 4.56 | 5.70 | 6.84 |
| TC4340 | 0.043 | 229 | 4.18 | 5.70 | 6.84 | 7.98 |
| TC4365 | 0.043 | 381 | 4.18 | 5.70 | 6.84 | 7.98 |
| TC4895 | 0.048 | 559 | 4.56 | 6.46 | 7.98 | 9.50 |
| TC5240 | 0.052 | 229 | 5.32 | 7.60 | 9.12 | 10.64 |
| TC5265 | 0.052 | 381 | 5.32 | 7.60 | 9.12 | 10.64 |
| TC6265 | 0.062 | 381 | 7.98 | 11.40 | 14.06 | 15.96 |
| TC7265 | 0.072 | 381 | 10.64 | 15.20 | 18.62 | 15.96 |
| TC8565 | 0.085 | 381 | 15.58 | 21.66 | 25.46 | 30.82 |

Spray gun accessories

| Model | Description | For use with: |
|-----------|---|--|
| 66504 | Tip Guard and Nut Secure TC-XXX tip to gun; guard required on airless applications. Order tips separately. | • All manual/automatic spray guns |
| 651555-B | Quick Clean Spray tip locked in operating position until reversed with lever for cleaning. For spraying heavy-viscosity material. Order tips separately. | • All manual/automatic spray guns |
| 651551 | Quick Clean Spray tip locked in operating position until reversed with lever for cleaning. For spraying heavy-viscosity material. Order TC-XXXX spray tip separately. | • 651500-1 guns • NOTE: To adapt 651551 to fit 651533, order 76555 pilot, 92367 retaining nut, Y167-1-1/8" (M) x 1/4" (F) adapter |
| 65030-X-B | Swivel and Filter Assembly 1/4" NPT(M) x 1/4" NPS(F); swivels 360°. 6700-psi (462.3-bar) maximum working pressure | • All manual / automatic spray guns |
| 65030-1-B | Swivel, no filter | — |
| 65030-5-B | Swivel, 100-mesh stainless steel filter | — |
| 65030-9-B | Swivel, 60-mesh stainless steel filter | — |



651555-B



651551



65030-1

Dollies, Hand Trucks

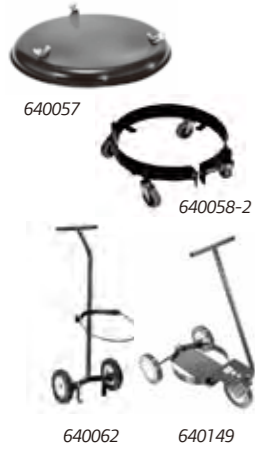

DOLLIES

| Model | Description | For use with: |
|----------|---|---|
| 640057 | Platform-type dolly has four swivel casters and three drum clamps | • Steel or fiber drums • 16-gallon drums |
| 640058-2 | Band-type dolly has four rubber-wheeled casters and screw damp | • Steel or fiber drums • 16-gallon drums |

HAND TRUCKS

| Model | Description | For use with: |
|--------|--|-------------------|
| 640062 | Two-wheel truck has clamp rod and two base supports to hold drum; wheel are rubber | • 16-gallon drums |
| 640149 | Three-wheel truck includes hinged handle, swivel-type front wheel, and two 6" rubber rear wheels | • 16-gallon drums |

Material heaters and filters



Fluid heaters

Cast aluminum with stainless steel fluid passages. Externally adjustable thermostat is variable from 15 C° to 120 C°. Explosion proof construction for Class 1, Group D hazardous environments. CSA approved.

| Model no. | Voltage | AMPS | Accuracy | Temp. rise above ambient | Recovery | Working pressure | Fluid inlet /outlet |
|------------|---------|----------|----------|--------------------------|----------|------------------|---------------------|
| 651747-1-B | 120VAC | 16.6 Amp | ± 1.9° C | 38° C | 56.8 L/h | 345 bar | 1/2" NPTF |
| 651747-2-B | 240VAC | 8.3 Amp | ± 1.9° C | 38° C | 56.8 L/h | 345 bar | 1/2" NPTF |
| 651747-3-B | 440VAC | 4.5 Amp | ± 1.9° C | 38° C | 56.8 L/h | 345 bar | 1/2" NPTF |

Material filters



| Model no. | Inlet size / Quantity | Outlet size / Quantity | Max. fluid pressure | Filtration |
|------------------------------------|-----------------------|------------------------|---------------------|-------------|
| Carbon steel | | | | |
| 651412 | 1/4" NPTF / 2 | 1/4" NPTF / 3 | 345 bar | 200 microns |
| 651412-8 | 1/4" NPTF / 2 | 1/4" NPTF / 3 | 345 bar | 150 microns |
| Carbon steel, nickel plated | | | | |
| 651420-40 | 1/2" NPTF / 2 | 1/2" NPTF / 1 | 415 bar | 375 microns |
| 651420-70 | 1/2" NPTF / 2 | 1/2" NPTF / 1 | 415 bar | 200 microns |
| 651420-100 | 1/2" NPTF / 2 | 1/2" NPTF / 1 | 415 bar | 150 microns |
| 651418-40-B | 1" NPTF / 2 | 3/8" NPTF / 3 | 415 bar | 375 microns |
| 651418-70-B | 1" NPTF / 2 | 3/8" NPTF / 3 | 415 bar | 200 microns |
| 651418-100-B | 1" NPTF / 2 | 3/8" NPTF / 3 | 415 bar | 150 microns |
| 651421-70 | 1" NPTF / 1 | 3/4" NPTF / 1 | 415 bar | 200 microns |
| Stainless steel | | | | |
| 651422-40 | 1/2" NPTF / 2 | 1/2" NPTF / 1 | 415 bar | 375 microns |
| 651422-70 | 1/2" NPTF / 2 | 1/2" NPTF / 1 | 415 bar | 200 microns |
| 651422-100 | 1/2" NPTF / 2 | 1/2" NPTF / 1 | 415 bar | 150 microns |

Material filter screens



| Model no. | Screen mesh | Filtration | Filter used with : |
|-----------|-------------|-------------|--------------------|
| 91192-2 | 70 | 200 microns | 651412 |
| 91192-3 | 100 | 150 microns | 651412 |
| 91192-4 | 200 | 75 microns | 651412 |
| 93944-40 | 40 | 375 microns | 651420 & 651422 |
| 93944-70 | 70 | 200 microns | 651420 & 651422 |
| 93944-100 | 100 | 150 microns | 651420 & 651422 |
| 93945-40 | 40 | 375 microns | 651418 |
| 93945-70 | 70 | 200 microns | 651418 |
| 93945-100 | 100 | 150 microns | 651418 |

Oil control handles

Non-metered fluid control handles



| Model | Description | Working pressure | Fluid inlet | Fluid outlet |
|-----------------------------------|---|------------------|-------------|--------------|
| High volume | | | | |
| 635193 | Has flexible rubber hose with non-drip nozzle – use with 1:1 and 3:1 pumps. | 41 bar Max. | 3/4" NPTF | Non-drip tip |
| 635395-2 | Has flexible rubber hose with non-drip nozzle – use with 5:1 and 9:1 pumps. | 63 bar Max. | 3/4" NPTF | Non-drip tip |
| Standard volume | | | | |
| 635392 | Has flexible rubber hose, built-in swivel, filter and non-drip nozzle. | 69 bar Max. | 1/2" NPTF | Non-drip tip |
| 635399 | Has flexible rubber hose, built-in swivel and right-angle non-drip nozzle. | 69 bar Max. | 1/2" NPTF | Non-drip tip |
| For water & antifreeze | | | | |
| 635129 | Radiator type bibb – Zinc die casting with brass, and nitrile seals. | 21 bar Max. | 1/4" NPTF | Non-drip tip |

Handles with preset metered flow control

Preset unit automatically shuts off when set quantity of fluid is delivered and meter indicator returns to zero.



| Model | Description | Working pressure | Fluid inlet | Fluid outlet |
|-----------|---|------------------|-------------|-----------------------------|
| 635360-2 | Digital totalizer registers up to 9.999 Liters. | 69 bar Max. | 1/2" NPTF | Non-drip flex extension |
| 635360-22 | Digital totalizer registers up to 9.999 Liters. | 69 bar Max. | 1/2" NPTF | Non-drip rigid extension |
| 635367 | Totalizer registers from 1 to 60 liters | 69 bar Max. | 1/2" NPTF | 14 mm diameter non-drip tip |

Digital metered fluid control handles

Our metered control handle features a patented oval gear wheel design for precise and reliable measurement. Its digital LCD readout operates on two standard alkaline batteries. This control handle is also available without meter.



| Model | Max. flow rate | Working pressure | Fluid inlet | Fluid outlet |
|----------------------------|----------------|------------------|-------------|--------------------------------|
| Metered handles | | | | |
| 635390-33 | 15 L | 69 bar Max. | 1/2" NPTF | Non-drip tip / rigid nozzle |
| 635390-3 | 15 L | 69 bar Max. | 1/2" NPTF | Non-drip tip / flexible nozzle |
| 635390-30 | 15 L | 69 bar Max. | 1/2" NPTF | Delivered without nozzle |
| Non metered handles | | | | |
| 635391-11 | 15 L | 69 bar Max. | 1/2" NPTF | Non-drip tip / rigid nozzle |
| 635391-1 | 15 L | 69 bar Max. | 1/2" NPTF | Non-drip tip / flexible nozzle |
| Digital meter only | | | | |
| 635190-3 | 15 L | 69 bar Max. | 1/2" NPTF | — |

Oil control handles (continued)

Non-drip Nozzle / Hose for motor oil, gear oil and transmission fluids



| Model | Description | Fluid inlet | Length | Working pressure |
|----------|--------------|-------------|--------|------------------|
| 629212 | 180° | 3/4" NPT | 300 mm | 62 bar |
| 629516 | 180° | 1/2" NPT | 330 mm | 69 bar |
| 629521 | 90° | 1/2" NPT | 380 mm | 69 bar |
| 6786 | 90° / Rigid | 1/4" NPT | 165 mm | 69 bar |
| 60798 | 180° / Rigid | 1/2" NPT | 130 mm | 69 bar |
| 629245-1 | 180° | 1/2" NPT | 381 mm | 69 bar |
| 629245-2 | 180° / Rigid | 1/2" NPT | 330 mm | 69 bar |

High-pressure grease control handles

Grease control handles

Model no. 636101

Dispenses lubricant at line pressure for lubricating grease fittings – Does not include nozzle or hydraulic coupler – For applications requiring high-flow capacity – Remove the 1/8" (M) x 3/8" (M) adapter for 3/8" (F) porting.

Model no. 636111

Dispenses lubricant at line pressure for lubricating grease fittings – Includes inlet material filter and curved nozzle with hydraulic coupler – Remove the 1/8" (M) x 3/8" (M) adapter for 3/8" (F) porting.

Model no. 636103

High-pressure booster handle delivers line pressure for normal lubrication – Trigger booster feature delivers 10,000 psi (690 bar) to loose tougher fittings – Includes curved nozzle with hydraulic coupler, inlet material filter and manual pressure vent for easy disconnection – Do not use with whip hose.



| Model | Working pressure | Fluid inlet | Fluid outlet |
|--------|------------------|------------------------|---------------------------|
| 636101 | 500 bar Max. | 3/8" NPTF | 11/16"-16 UN or 1/8" NPTF |
| 636111 | 500 bar Max. | 1/8" NPTM or 3/8" NPTF | Coupler |
| 636103 | 500 bar Max. | 1/8" NPTM or 3/8" NPTF | Coupler |

Whip hose for grease control handles

Model no. 629742

Extra-long, wire braid whip hose with hydraulic coupler and swivel – Overall length 0.75 m – For use with coupler 636111 control handle – Allows operator to access hard-to-reach fittings.

Max. working pressure 345 bar, Fluid inlet 1/8" NPTF.



Low-Profile Dispensing Valves

Spray valves for the atomization of low-viscosity fluids

These compact, air-operated, automatic spray valves provide air-atomized application of low-viscosity fluids. They are designed to be used with either supply pumps or pressure tanks. Several unique design features seal the material from outside air and moisture and prevent premature curing of material, which allows for either continuous or intermittent use and reduces the need for daily cleanup.

Compact design provides mounting versatility

The narrow dimensions, block shape, and hose placement allow installation in narrow, recessed areas. Multiple valves can be grouped together in an area normally occupied by a single conventional spray valve.

Spray Patterns

Unique spray patterns matched to application requirements

To meet the needs of your individual application, both flat and round spray patterns are available. For wide surface coverage with minimum film thickness, flat spray models are available in both 90 degree and 45 degree spray patterns. For a more focused pattern with a thicker film build or a conical substrate, the round spray models are the appropriate choice.

Extrusion valves for precise applications of bead patterns

For applications that require a precise bead of material rather than a sprayed coating, several extrusion valves are available. Like the spray valves, separate air pressure and material flow adjustments provide regulation of emissions for material savings and precise, accurate patterns.

Multiple valves can be grouped together to achieve a multiple-bead pattern.

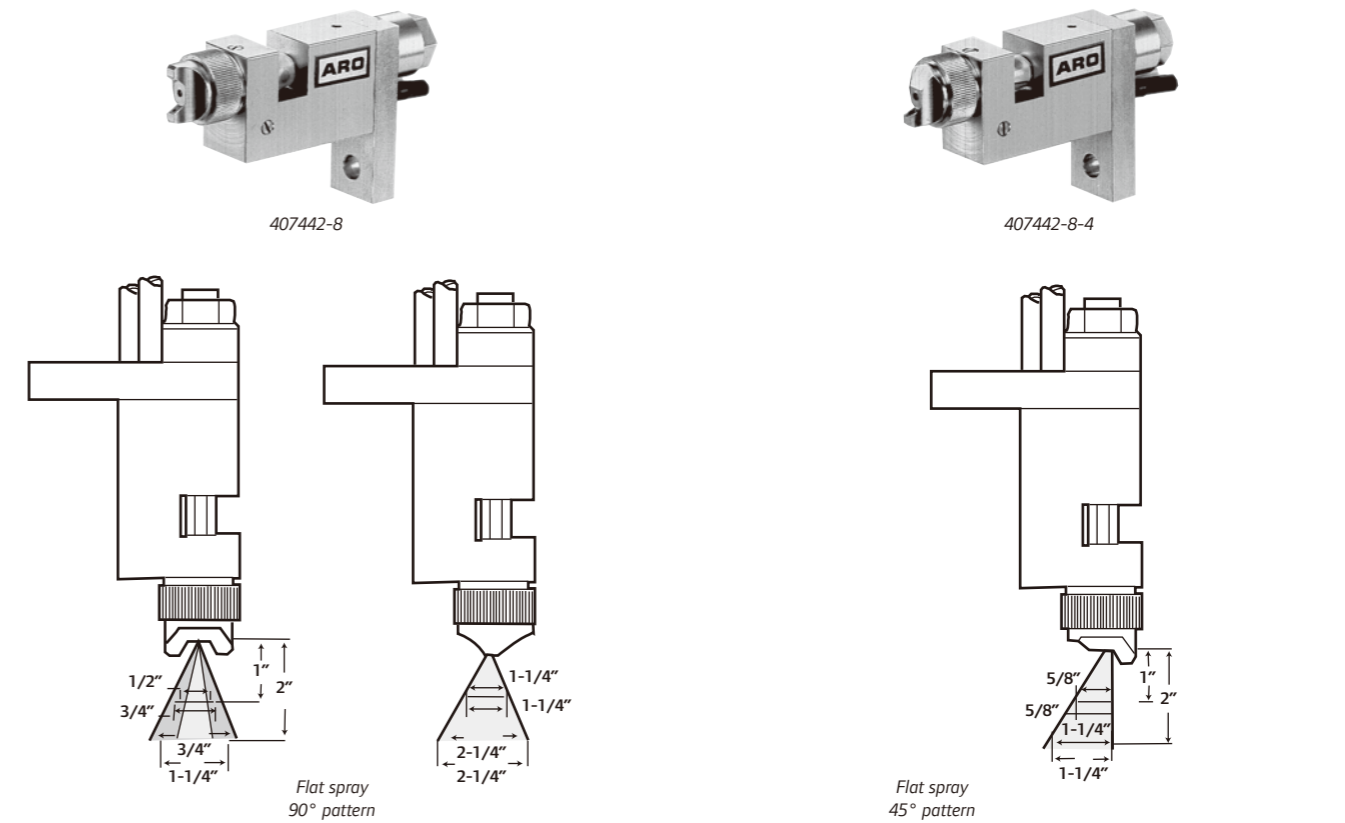

| Model | Material Pressure psi (bar) | Control Air psi (bar) | Atomizing Air psi (bar) |
|-----------|-----------------------------|-----------------------|-------------------------|
| 407442-XX | 15 (1.0) | 55 (3.8) | 20 (1.4) |
| | 30 (2.1) | 90 (6.2) | 35 (2.4) |

| Model | Material Pressure psi (bar) | Control Air psi (bar) | Atomizing Air psi (bar) |
|-------------|-----------------------------|-----------------------|-------------------------|
| 407442-XX-4 | 15 (1.0) | 55 (3.8) | 20 (1.4) |
| | 30 (2.1) | 90 (6.2) | 35 (2.4) |

| Model | Tip Diameter mm | Fluid Inlet NPT(M) | Atomizing Air Inlet NPT(M) | Control Air Inlet NPT(M) | Minimum Control Air Required psi (bar) | Max Fluid Operating Pressure psi (bar) | Recommended Range Atomizing Air Pressure psi (bar) |
|---------------------------------------|-----------------|--------------------|----------------------------|--------------------------|--|--|--|
| Flat Spray — 90° Pattern | | | | | | | |
| 407442-8 | 0.8 | 1/4" | 1/4" | 1/8" | 55 (3.7) | 180 (12) | 7.5 – 37.5 (0.5 – 2.5) |
| 407442-10 | 1 | 1/4" | 1/4" | 1/8" | 55 (3.8) | 180 (12) | 7.5 – 37.5 (0.5 – 2.5) |
| 407442-15 | 1.5 | 1/4" | 1/4" | 1/8" | 55 (3.7) | 180 (12) | 7.5 – 37.5 (0.5 – 2.5) |
| Flat Spray — 45° Pattern | | | | | | | |
| 407442-8-4 | 0.8 | 1/4" | 1/4" | 1/8" | 55 (3.7) | 180 (12) | 7.5 – 37.5 (0.5 – 2.5) |
| 407442-10-4 | 1 | 1/4" | 1/4" | 1/8" | 55 (3.7) | 180 (12) | 7.5 – 37.5 (0.5 – 2.5) |
| 407442-15-4 | 1.5 | 1/4" | 1/4" | 1/8" | 55 (3.7) | 180 (12) | 7.5 – 37.5 (0.5 – 2.5) |
| Round Spray — Focused Pattern | | | | | | | |
| 407443-8 | 0.08 | 1/4" | 1/4" | 1/8" | 90 (6) | 90 (6) | 7.3 – 37.5 (0.5 – 2.5) |
| 407443-12 | 1.2 | 1/4" | 1/4" | 1/8" | 90 (6) | 90 (6) | 7.3 – 37.5 (0.5 – 2.5) |
| 407443-20 | 2 | 1/4" | 1/4" | 1/8" | 90 (6) | 90 (6) | 7.3 – 37.5 (0.5 – 2.5) |
| Round Spray — Diffused Pattern | | | | | | | |
| 407441-8 | 0.08 | 1/4" | 1/4" | 1/8" | 55 (3.7) | 180 (12) | 7.3 – 37.5 (0.5 – 2.5) |
| 407441-10 | 1 | 1/4" | 1/4" | 1/8" | 55 (3.7) | 180 (12) | 7.3 – 37.5 (0.5 – 2.5) |
| 407441-15 | 1.5 | 1/4" | 1/4" | 1/8" | 55 (3.7) | 180 (12) | 7.3 – 37.5 (0.5 – 2.5) |
| Extrusion ValveS | | | | | | | |
| 407444-3 | 0.3 | 1/4" | 1/4" | 1/4" | 90 (6) | 1,000 (69) | None required |
| 407444-5 | 0.5 | 1/4" | 1/4" | 1/4" | 90 (6) | 1,000 (69) | None required |
| 407444-7 | 0.7 | 1/4" | 1/4" | 1/4" | 90 (6) | 1,000 (69) | None required |

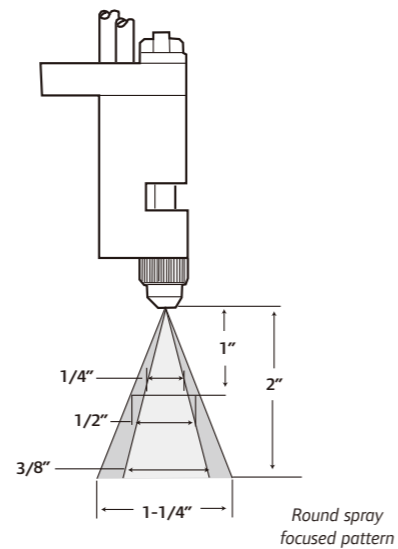
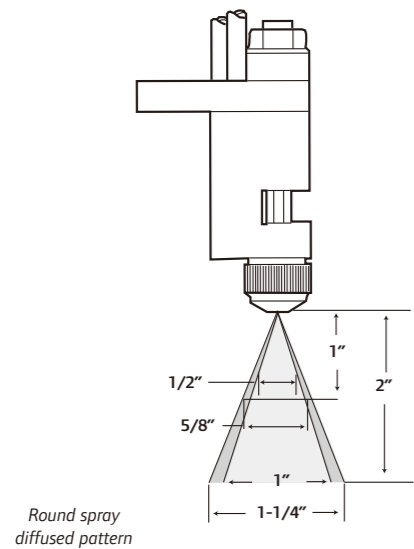

| Model | Material Pressure psi (bar) | Control Air psi (bar) | Atomizing Air psi (bar) |
|-----------|-----------------------------|-----------------------|-------------------------|
| 407441-XX | 15 (1.0) | 55 (3.8) | 20 (1.4) |
| 407446-XX | 30 (2.1) | 90 (6.2) | 35 (2.4) |

| Model | Material Pressure psi (bar) | Control Air psi (bar) | Atomizing Air psi (bar) |
|-----------|-----------------------------|-----------------------|-------------------------|
| 407443-XX | 15 (1.0) | 55 (3.8) | 20 (1.4) |
| | 30 (2.1) | 90 (6.2) | 35 (2.4) |

Swivels

Swivels are used to give mobility and flexibility for material hoses and dispensing guns. Select the proper working pressure and check the compatibility of the seals with the material being pumped.

| Model | Thread Size NPT x NPT in | Type of Seals | Max Working Pressure psi (bar) |
|------------------------|--------------------------|---|--------------------------------|
| STRAIGHT SWIVEL | | | |
| 636075 | 1/8" (M) x 1/8" (F) | Fabric with neoprene | 10,000 (689.4) |
| 636085 | 3/8" (M) x 3/8" (F) | Fabric with neoprene | 10,000 (689.4) |
| 635107 | 3/8" (M) x 1/2" (F) | Fabric with neoprene | 2,000 (137.8) |
| 635117 | 1/2" (M) x 1/2" (F) | Fabric with neoprene | 2,000 (137.8) |
| 635108 | 3/4" (M) x 3/4" (F) | Fabric with neoprene | 1,000 (68.9) |
| Z 360° SWIVEL | | | |
| 636077 | 1/8" (M) x 1/8" (F) | Fabric with neoprene | 10,000 (689.4) |
| 636083 | 1/8" (F) x 3/8" (F) | Fabric with neoprene | 10,000 (689.4) |
| 636084 | 1/8" (F) x 1/4" (F) | Fabric with neoprene | 10,000 (689.4) |
| 636086-B | 1/4" (F) x 1/4" (M) | Fabric with neoprene | 6,700 (461.8) |
| 636087-B | 1/4" (F) x 1/4" (M) | Fabric with neoprene Includes 67176-5 edge-type filter element | 6,700 (461.8) |
| 636088 | 3/8" (M) x 3/8" (F) | Fabric with neoprene | 10,000 (689.4) |
| 635106 | 1/2" (F) x 3/8" (M) | Fabric with neoprene | 10,000 (689.4) |



636075



636077

Agitators

| Model | Container Size gal | Drum Cover | Air Motor Number | hp (kW) | Motor rpm | Mount | Diameter in (mm) | Length in (mm) | Rod Model | Material |
|----------|--------------------|-------------------------|------------------|------------|-------------|--------|------------------|----------------|-----------|-----------------------|
| 651100 | 5 | 651851 drum cover | 650252 | 1/3 (.25) | 500 – 1,000 | Hub | 1/2" (12.7) | 12" (305) | 92094-4 | 416 stainless steel |
| 651104-3 | 5 | drum cover | 650250 | 3/4 (0.56) | 300 – 3,000 | Flange | 1/2" (12.7) | 10.5" (267) | 92094-3 | 316SS stainless steel |
| 60307-1 | 55 | 61729, 66197 drum cover | 650250 | 3/4 (.56) | 300 – 3,000 | Flange | 1/2" (12.7) | 32" (813) | 73120 | Carbon steel |
| 651103 | 55 | Drum side mount | 650250 | 3/4 (.56) | 300 – 3,000 | Flange | 1/2" (12.7) | 32" (813) | 92094-1 | 316 stainless steel |
| 651104-1 | 55 | 66197 drum cover | 650250 | 3/4 (.56) | 300 – 3,000 | Flange | 1/2" (12.7) | 32" (813) | 92094-1 | 316SS stainless steel |

Propeller Specifications

| Model | Number of Props | Diameter in (mm) | Prop Number | Material | Prop Direction |
|----------|-----------------|------------------|--------------|---------------------|----------------|
| 651100 | 1 | 4" (102) | 94783-1 | 316 stainless steel | CCW |
| 651104-3 | 1 | 5" (127) | 94783-1 | 316 stainless steel | CCW |
| 60307-1 | 2 | 5" (127) | 73121, 73122 | 316 stainless steel | CCW |
| 651103 | 2 | 5" (127) | 94783-1 | 316 stainless steel | CCW |
| 651104-1 | 2 | 5" (127) | 94783-1 | 316 stainless steel | CCW |



651100



651103



651104-3



651104-1

Airline accessories



635040



23644-400

ARO Stop® over-run controls

ARO-STOP® Valve shuts off air to the pump when material container is empty or line is broken. Quick set and reset feature.

| Model no. | Compatible air motor size | Air inlet / outlet | Pressure range |
|-----------|---------------------------|---------------------------|----------------|
| 635040 | 2" & 3" | 1/4" NPT(F) / 1/4" NPT(M) | 1.4 - 12 bar |
| 23644-400 | 4 1/4", 6" | 1/2" NPT(F) / 1/2" NPT(M) | 1.4 - 12 bar |
| 635043 | 8", 10" & 12" | 3/4" NPT(F) / 3/4" NPT(M) | 1.4 - 12 bar |

Air Motor Mufflers

Reduces air exhaust noise level to acceptable OSHA standards.



| Model no. | Compatible air motor size | Diameter | Length |
|-----------|---------------------------|----------|--------|
| 67445-1 | 4 1/4" | 133 mm | 393 mm |
| 67445-2 | 6" | 133 mm | 419 mm |
| 67445-3 | 8" | 133 mm | 444 mm |
| 67445-4 | 10" | 133 mm | 470 mm |
| 67445-5 | 12" | 133 mm | 495 mm |

Air filters regulators

The ARO-Flo Series units extend the life of air operated equipment while reducing operating costs.

- Max. inlet pressure: 17 bar (250 psi).
- Filter element 5 μ.
- Metallic bowl (with sight glass on 1/2" and 3/4" models).
- Gauge.
- Temperature range: -18°C to +79°C.



P39124-620



P39344-610



P39454-610

| Model no. | Used with motor: | Air inlet | Pressure range | Max. flow | Bowl capacity (F / L) | Width, height, depth |
|------------|------------------|-----------|----------------|-----------|-----------------------|----------------------|
| P39124-620 | 2" & 3" | 1/4" NPT | 0 - 10 bar | 22 l/s | 11 ml | 40 x 157 x 74 mm |
| P39344-610 | 4 - 1/4" & 6" | 1/2" NPT | 0 - 10 bar | 81 l/s | 68 ml | 70 x 225 x 80 mm |
| P39454-610 | 8", 10" & 12" | 3/4" NPT | 0 - 10 bar | 111 l/s | 150 ml | 90 x 347 x 104 mm |



Filter element 40 μ

Air control needle valve



104104-N02



104393-5

| Model no. | For use with FRL: |
|-----------|-------------------|
| 104296 | P39124-620 (1/4") |
| 104318 | P39344-610 (1/2") |
| 104446 | P39454-610 (3/4") |

| Model no. | Port size | Compatible air motor size |
|-----------------------|-----------|---------------------------|
| Needle valve | | |
| 104104-N02 | 1/4" NPT | 2" & 3" |
| 104104-N52 (1) | 1/4" NPT | 2" & 3" |
| 104104-N04 | 1/2" NPT | 4 1/4" & 6" |
| 104104-N06 | 3/4" NPT | 8" 10" & 12" |
| Lock-out valve | | |
| 104390-2 | 1/4" NPT | 2" & 3" |
| 104392-4 | 1/2" NPT | 4 1/4" & 6" |
| 104393-5 | 3/4" NPT | 8" 10" & 12" |

(1) Stainless steel needle and inserts.

Applications of the lubrication pumps



Lubrication



Ingersoll Rand / ARO lubrication equipment reflects the same high standards of performance as the Ingersoll Rand / ARO Process Diaphragm and Piston Pumps., with a full range of products that will keep all types of fluids moving efficiently. They are backed by more than 70 years of experience in pump and air system technology, and include models specifically designed for popular applications. They include:

- **Oil Pumps & Packages:** Piston and diaphragm pumps to handle all types of motor oil, gear oil, and transmission type fluids - These pumps are designed to pump from different sized drums and tank units.
- **Grease Pumps & Packages:** Grease pumps and packages designed to handle different drum sizes and applications in the workplace.
- **Speciality pumps:** Pump designed for high pressure cleaning. Wash pump can handle degreasers, detergents, cleaning solutions, water and metal brighteners etc.



Oil
Grease

6120 Series

Lubrication piston pumps

Oil pumps

1:1 ratio pumps ideal for pumping motor oil, gear oil, and transmission fluids. Models available for 200 L and 1000 L drums (bung adaptor included).

| 612041-X | |
|-----------------|------------------------------|
| ?:1 | 1:1 |
| Motor | 2" (51 mm) |
| Max. bar | 0 - 10.3 bar |
| Max. bar | 0 - 10.3 bar |
| 1 min. | 18.5 l/min (23.1 L/min. MAX) |
| AIR | 1/4" NPT(F) |
| | Immersed |
| | 3/4" NPT(F) |

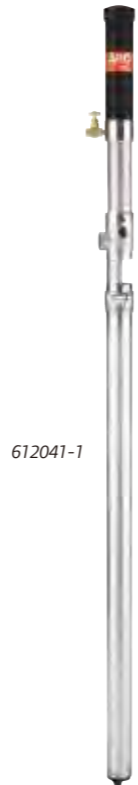

612041-1



612042-1

| Pump model no. | Type | Plunger material | Packings | ServiceKit (1) |
|--------------------------|-------------------|------------------|----------|----------------|
| Carbon steel pump | | | | |
| 612041-1 | For 200 L drum | Carbon steel | Buna | 637081 |
| 612041-3 | For 200 L drum | | PTFE | 637083 |
| 612042-1 | Stub (wall mount) | | Buna | 637081 |

(1) Lower pump repair kit

Oil
Grease

LM Series

Lubrication piston pumps

Standard features

LM Series piston pumps deliver unmatched industrial-strength performance for pumping fluids with sizes to fit small (60 L oil / 16 kg grease) or large (1000 L oil / 180 kg grease) containers.

- Pump's patented design improves flow, reduces pulsation, and extends service life.
- Offers simple self-service maintenance due to advanced design with 50% fewer parts.
- Reduces service time, due to in-line service design with no special tools required.
- Features stall-free, ice-free air motor with tough, durable housing.

Oil pumps

| | LM2203A-XX-C | LM2305A-XX-B |
|-----------------|--------------------------|--------------------------|
| ?:1 | 3:1 | 5:1 |
| Max. bar | 0 - 10.3 bar | 0 - 10.3 bar |
| Max. bar | 0 - 31 bar | 0 - 51.7 bar |
| 1 min. | 23 l/min (34 L/min. MAX) | 23 l/min (34 L/min. MAX) |
| AIR | 1/4" NPT(F) | 1/4" NPT(F) |
| | 3/4" | 1 1/2" |
| | 1/2" NPT(F) | 1/2" NPT(F) |

Ordering menu

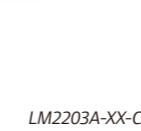
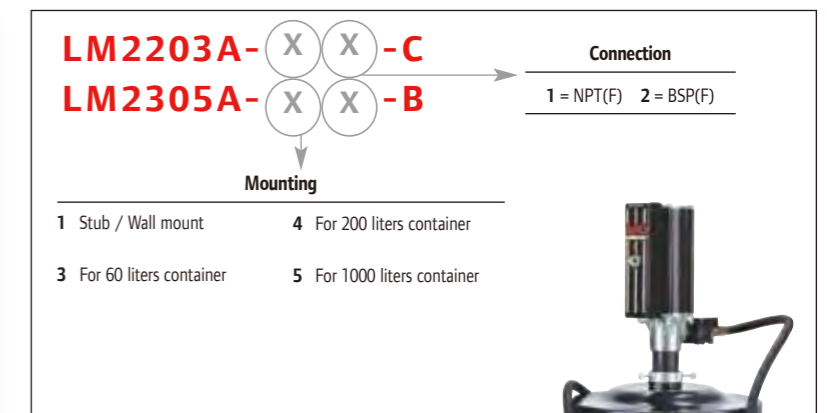

LM2203A-XX-C



LM2305A-11-B



LP3101-1-B

Oil pump packages

| Model | Mounting | Pump model | Meter (in L) | Control handle | Dolly | Drum cover | Hose | Valve |
|-------------------------|----------------|--------------|--------------|----------------|----------|------------|----------|-------|
| 3:1 2" Air motor | | | | | | | | |
| LP2100-1-B | 60 L container | LM2203A-31-C | 635190-1 | 635391-1 | 640058-2 | 94421 | 623501-6 | 67086 |
| LP2101-1-B | 60 L container | LM2203A-31-C | 635190-3 | 635391-1 | 640058-2 | 94421 | 623501-6 | 67086 |
| 5:1 3" Air motor | | | | | | | | |
| LP3100-1-B | 60 L container | LM2305A-31-B | 635190-1 | 635391-1 | 640058-2 | 94421 | 623501-6 | — |
| LP3101-1-B | 60 L container | LM2305A-31-B | 635190-3 | 635391-1 | 640058-2 | 94421 | 623501-6 | — |

Oil
Grease

LM Series

Lubrication piston pumps

Grease pumps



| | LM2250E-XX-B | LM2350E-XX-B |
|-----------------|--------------------------|----------------------------|
| ?:1 | 50:1 | 50:1 |
| Max. bar | 0 - 10.3 bar | 0 - 10.3 bar |
| Max. bar | 0 - 515 bar | 0 - 515 bar |
| 1 min. | 1 kg/min (4 kg/min. MAX) | 2 kg/min (3.4 kg/min. MAX) |
| AIR | 1/4" | 1/4" |
| | 3/8" | 3/8" |

Ordering menu

LM2250E-X X -B
LM2350E-X X -B

Connection
 1 = NPT(F) 2 = BSP(F)

Mounting*
 2 For 16 kg container 4 For 180 kg container
 3 For 55 kg container 6 For 27 kg container * 2" NPSM bung adapter

Grease pump packages

| Model | Mounting | Pump model | Control handle | Dolly | Drum cover | Hose | Follower plate | Adapter | Z-Swivel |
|--------------------------|-------------------|--------------|----------------|----------|------------|-----------|----------------|----------|------------------------|
| 50:1 2" Air motor | | | | | | | | | |
| LP2001-1-B | 16 kg container | LM2250E-21-B | — | — | 94420 | — | 640095-2-B | — | — |
| LP2002-1-B | 16 kg container | | 636111 | — | 94420 | 624201-10 | 640095-2-B | 76493 | 636077 |
| LP2003-1-B | 55 kg container | | — | — | 94421 | — | 640165 | — | — |
| LP2004-1-B | 55 kg container | LM2250E-31-B | 636111 | — | 94421 | 624201-10 | 640165 | 76493 | 636077 |
| LP2006-1-B | 55 kg container | | 636111 | 640058-2 | 94421 | 624201-10 | 640165 | 76493 | 636077 |
| LP2007-1-B | 55 kg container | | 636111 | 640062 | 94421 | 624201-10 | 640165 | 76493 | 636077 |
| LP2009-2-B | 17.5 kg container | LM2250E-22-B | 80192206 | 80192305 | 80192222 | 80192412 | 80192420 | 80192214 | With in control handle |
| LP2010-2-B | 25 kg container | | 80192206 | 80192305 | 80192222 | 80192412 | 80192370 | 80192214 | With in control handle |
| 50:1 3" Air motor | | | | | | | | | |
| LP3001-1 | 16 kg container | LM2350E-21-B | 636103 | — | 94420 | 624201-10 | 640095-2-B | 76493 | 636077 |
| LP3002-1 | 55 kg container | LM2350E-31-B | — | — | 94421 | 624401-4 | 640165 | — | — |
| LP3003-1 | 55 kg container | | 636103 | 640057 | 94421 | 624201-10 | 640165 | 76493 | 636077 |
| LP3004-1 | 55 kg container | | 636111 | 640058-2 | 94421 | 624201-10 | 640165 | 76493 | 636077 |
| LP3005-1 | 180 kg container | LM2350E-41-B | — | — | 94422 | 624401-4 | — | — | — |
| LP3006-1 | 55 kg container | LM2350E-31-B | 636103 | 640062 | 94421 | 624201-10 | 640165 | 76493 | 636077 |
| LP3007-1 | 27 kg container | LM2350E-61-B | 636111 | — | 62050 | 624401-6 | — | — | 636077 |
| LP3008-1 | 16 kg container | LM2350E-21-B | — | — | 94420 | 624201-10 | 640095-2-B | 76493 | — |
| LP3009-1 | 180 kg container | LM2350E-41-B | — | — | 94422 | 624401-4 | 640015-1 | — | — |

Oil
Grease

AFX Series

Heavy service lubrication pumps

Oil pumps

9:1 pump ratio and 4 1/4" (108 mm) diameter air motor. These pumps are ideal for pumping heavy oils over long distances.

| AF0409AXXPFL1-1 | |
|-----------------|---------------------------------------|
| ?:1 | 9:1 |
| Motor | 4 1/4" (108 mm) |
| Max. bar | 0 - 10.3 bar |
| Max. bar | 0 - 93 bar |
| 1 min. | 14.8 l/min |
| AIR | 1/2" NPT(F) |
| | Immersed |
| | 3/4" NPT(F) |
| | 15.4 kg (Stub; 60L) 16.3 kg (200L) |

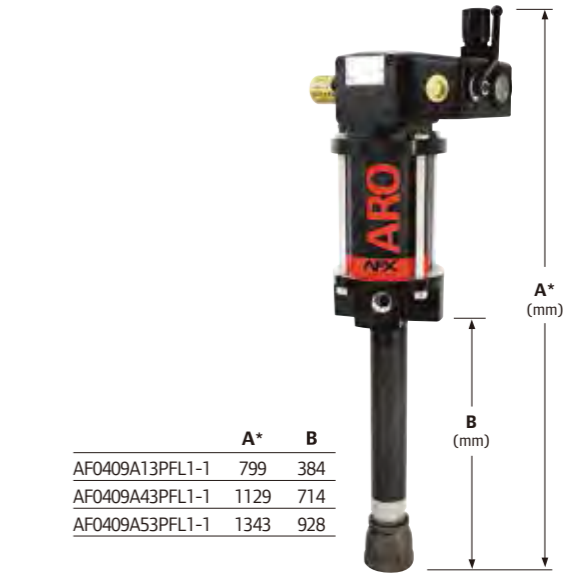

| | A* | B |
|-----------------|------|-----|
| AF0409A13PFL1-1 | 799 | 384 |
| AF0409A43PFL1-1 | 1129 | 714 |
| AF0409A53PFL1-1 | 1343 | 928 |

Model shown w/ball valve regulator
*For models without ball valve regulator subtract 52.83mm

| Pump model no. (1) | Type | Lower pump | Plunger material | Packings (upper + lower) | ServiceKit (2) |
|--------------------------|-------------------|------------|------------------|--------------------------|----------------|
| Carbon steel pump | | | | | |
| AF0409A13PFL1 | Stub (wall mount) | 60873 | Carbon steel | Polyurethane + UHMW-PE | 637486 |
| AF0409A43PFL1 | For 60 L drum | 65033-1 | | | 637486 |
| AF0409A53PFL1 | For 200 L drum | 65033 | | | 637486 |

(1) Add "-1" to Model No. for Ball Valve Regulator
(2) Lower pump repair kit

Oil pump package



DM0409A53PFL1000

| Model | Type | Pump model | Bung adapter | Material hose | Air hose | Material | Weight |
|------------------|----------------|---------------|--------------|---------------|----------|----------|---------|
| DM0409A53PFL1000 | For 200 L drum | AF0409A53PFL1 | 60869 | 623501-8 | 621501-5 | Aluminum | 23.6 kg |

Oil
Grease

AFX Series

Heavy service lubrication pumps

Grease pumps

These pumps are ideal where high pressures are demanded. When higher viscosity lubricants are being pumped, follower plates help maintain a good pump prime and continuous material flow.

| | AF0450LX3PKL1-1 | AF060BLX3PKL1-1 |
|--|---|-------------------------------|
| | 50:1 | 100:1 |
| | 4 1/4" (108 mm) | 6" (152 mm) |
| | 0 - 10.3 bar | 0 - 6.9 bar |
| | 0 - 515 bar | 0 - 690 bar ⁽¹⁾ |
| | 2.70 kg | 0.95 kg |
| | 1/2" NPT(F) | 1/2" NPT(F) |
| | Immersed | |
| | 1/2" NPT(F) | 1/2" NPT(F) |
| | 15.0 kg(20L) 15.9 kg(60L) 17.2 kg(200L) | 18.6 kg(60L) 19.5 kg(200L) |



| | A* | B |
|-----------------|------|-----|
| AF0450L23PKL1-1 | 944 | 551 |
| AF0450L43PKL1-1 | 1142 | 750 |
| AF060BL43PKL1-1 | 1069 | 676 |
| AF0450L53PKL1-1 | 1349 | 956 |
| AF060BL53PKL1-1 | 1318 | 926 |

Model shown w/ball valve regulator
*For models without ball valve regulator subtract 52.83mm

| Pump model no. ⁽¹⁾ | Type | Plunger material | Packings (upper + lower) | ServiceKit ⁽²⁾ |
|-------------------------------|----------------|------------------|----------------------------------|---------------------------|
| Carbon steel pump | | | | |
| AF0450L23PKL1 | For 20 L pail | Carbon steel | Polyurethane + Glass-filled PTFE | 637485 |
| AF0450L43PKL1 | For 60 L drum | | | 637485 |
| AF060BL43PKL1 ⁽³⁾ | | | | 637483 |
| AF0450L53PKL1 | For 200 L drum | | | 637485 |
| AF060BL53PKL1 ⁽³⁾ | | | | 637483 |

(1) Add "-1" to Model No. for Ball Valve Regulator

(2) Lower pump repair kit.

(3) WARNING: These 100:1 pumps deliver pressures up to 690 bar, which is in excess of the rated capacity of the accessories shown in this catalogue. They can only be used in permanently installed, where the pump is connected directly to piping with the proper rating for the application.

Grease pump packages



| Model | Type | Pump model | Drum cover | Bung adapter | Material hose | Air hose | Follower plate | Weight |
|------------------|----------------|-----------------|------------|--------------|---------------|----------|----------------|---------|
| PM0450L23PKL1C10 | For 20L drum | AF0450L23PKL1 | 80192222 | 67145-5 | 67468 | — | 651900 | 30.0 kg |
| DC0450L53PKL1000 | For 200 L drum | AF0450L53PKL1 | 60898 | 4148 | 624401-8 | 621501-5 | — | 25.4 kg |
| DM0450L53PKL1000 | | AF0450L53PKL1 | — | 4148 | 624401-8 | 621501-5 | — | 24.5 kg |
| DC060BL53PKL1C11 | | AF060BL53PKL1-1 | 71060-1 | 60870 | — | — | 640015-5 | 43.5 kg |
| DC060BL43PKL1C11 | For 60 L drum | AF060BL43PKL1-1 | 66715 | — | — | — | 640152-1 | 31.7 kg |

| Model | Type | Pump model | RAM model | Follower plate (model, seal and material) | Weight |
|------------------|------------------------|---------------|-----------|--|---------|
| SP0450L23PKL1E32 | 20 L / single-post RAM | AF0450L23PKL1 | RM051S-C | 651901 Single lip, polyethylene/urethane Carbon steel, nickel plated | 57.0 kg |

| Pump accessories | |
|------------------|-----------------------------|
| 67445-1 | High performance muffler |
| 23644-400 | AroStop valve |
| 637489 | Universal motor service kit |
| P39344-100 | Air filter/regulator |
| 104327 | Filter/regulator repair kit |
| 67442 | Ball Valve Regulator |



Specialty application pumps

| Specifications | |
|---------------------------|-----------------|
| ?:1 | 9:1 |
| Motor | 4 1/4" (108 mm) |
| AIR | 1/2" NPT(F) |
| Max. bar | 0 - 10.3 bar |
| 89.2 dBA @ 4.1 bar | |
| Max. bar | 0 - 103 bar |
| 1 min. | 14.8 l/min. |
| 1 cycle | 180 cc |
| 3/8" NPT(F) | |
| 15.9 kg | |



Model shown w/ball valve regulator
*For models without ball valve regulator subtract 52.83mm

Wash pump

Perfect for cleaning:

- Cars, trucks and engines
- Construction equipment
- Aircraft
- Farm equipment
- Plant structures
- Railroad equipment

With the application of:

- Degreasers
- Detergents
- Cleaning solutions
- Water
- Metal brighteners
- Aluminum brighteners

| Pump model no. | Lower pump | Plunger material | Packings (upper + lower) | ServiceKit (1) | |
|----------------|-------------|---------------------|--------------------------|---------------------|--------------|
| AF0409C81BBW2 | 1875C81BBW2 | 316 stainless steel | 316 stainless steel | Buna "N" + Buna "N" | K1875C81BB00 |

(1) Lower pump repair kit

Wash pump package



WP0409C81BBW2000

| Model | Type | Pump model | Wall bracket | Suction tube | Control handle | Spray tip | Weight |
|------------------|-------------------|---------------|--------------|--------------|----------------|-----------|---------|
| WP0409C81BBW2000 | Wash pump package | AF0409C81BBW2 | 61113 | 61139-1 | 641523 | TP6250-18 | 35.8 kg |

0.2:1

84.9 l/min

Hydraulic Pumps

4-ball piston pump

| Specifications | | | |
|-----------------|----------------|----------------------------------|-----------------------------|
| ?:1 | 0.2:1 | Max. bar | 0.7 - 19.2 bar |
| Motor | 2.062" (52 mm) | Cycle/min. | 50 cycles/min. |
| Motor | 5.7" (144 mm) | 1 min. | 84.9 l/min. @50 cycles/min. |
| AIR | 3/8" NPT(F) | 1 cycle | 1698 cc |
| Max. bar | 3.4 - 82.8 bar | For 1 litre | 0.5 cycle |
| oil | 1/2" NPT(F) | 1 1/2" NPT(F) / 2" NPT(M) | |
| Max. °C | 54°C | 1" NPT(F) | |
| 32.7 kg | | | |

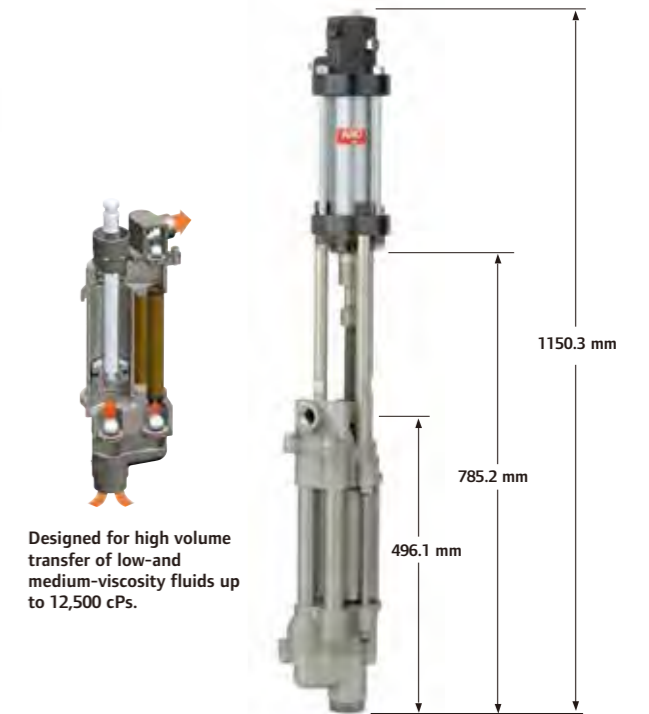

Designed for high volume transfer of low-and medium-viscosity fluids up to 12,500 cPs.

| Pump model no. | Lower pump | Plunger material | Packings (upper + lower) | ServiceKit (1) | |
|----------------|------------|-----------------------------------|---|---|------------|
| 650950-C4B | 67201-C4B | 300 Series / CF8M stainless steel | 17-4 stainless steel with ceramic coating | UHMW-PE + UHMW-PE | 637318-C4B |
| 650950-P4B | 67201-P4B | | | UHMW-PE/glass-filled PTFE + UHMW-PE | 637318-P4B |
| 650950-R4B | 67201-R4B | | | Glass-filled PTFE / UHMW-PE staggered + Virgin PTFE | 637318-R4B |

(1) Lower pump repair kit

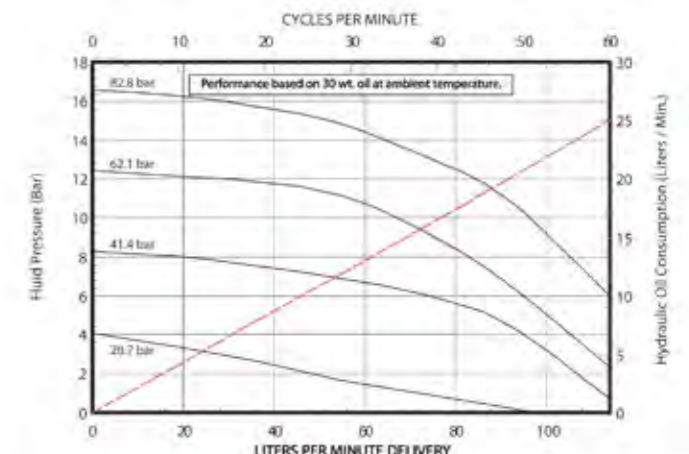
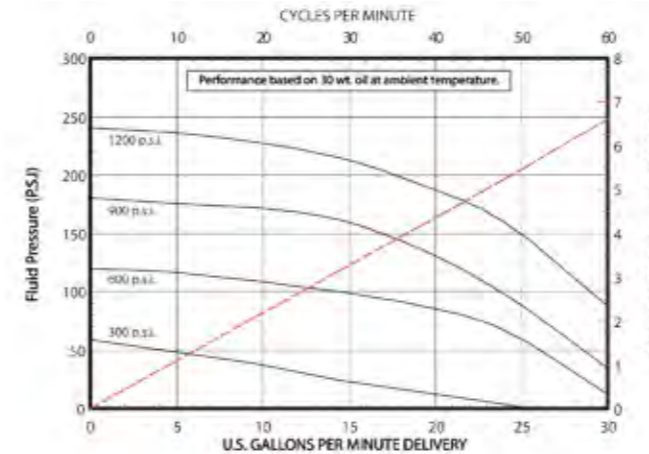

0.3:1

64.4 l/min

Hydraulic Pumps

4-ball piston pump

| Specifications | | | |
|-----------------|----------------|-------------|-----------------------------|
| ?:1 | 0.3:1 | Max. bar | 1.0 - 26.6 bar |
| Motor | 2.062" (52 mm) | Cycle/min. | 50 cycles/min. |
| Motor | 5.75" (146 mm) | 1 min. | 64.4 l/min. @50 cycles/min. |
| AIR | 3/8" NPT(F) | 1 cycle | 1288 cc |
| Max. bar | 3.4 - 82.8 bar | For 1 litre | 0.77 cycle |
| OIL | 1/2" NPT(F) | | 1 1/2" NPT(F) / 2" NPT(M) |
| Max. °C | 54 °C | | 1" NPT(F) |
| Weight | 31.8 kg | | |

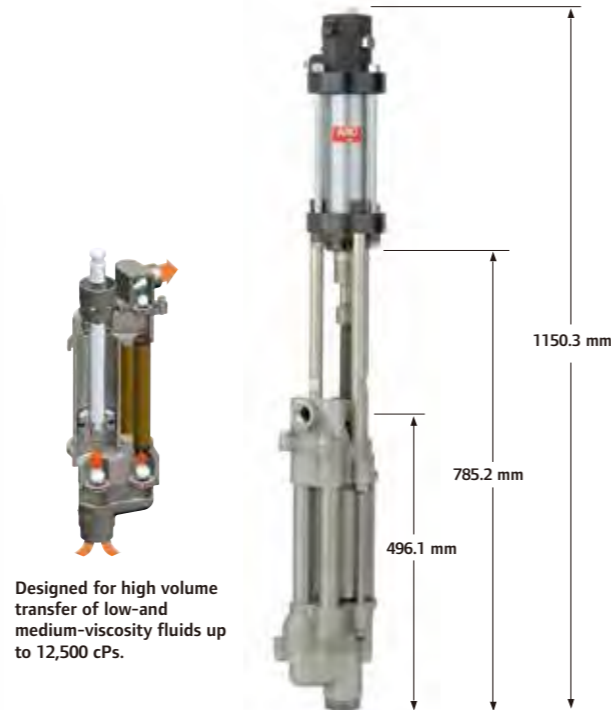

| Pump model no. | Lower pump | Plunger material | Packings (upper + lower) | ServiceKit (1) | |
|----------------|------------|-----------------------------------|---|-----------------|------------|
| 650949-C4B | 67200-C4B | 300 Series / CF8M stainless steel | 17-4 stainless steel with ceramic coating | UHMW-PE+UHMW-PE | 637317-C4B |
| 650949-74B | 67200-74B | | Glass-filled PTFE + Virgin PTFE | 637317-74B | |
| 650949-R4B | 67200-R4B | | UHMW-PE/glass-filled PTFE + UHMW-PE | 637317-R4B | |

(1) Lower pump repair kit

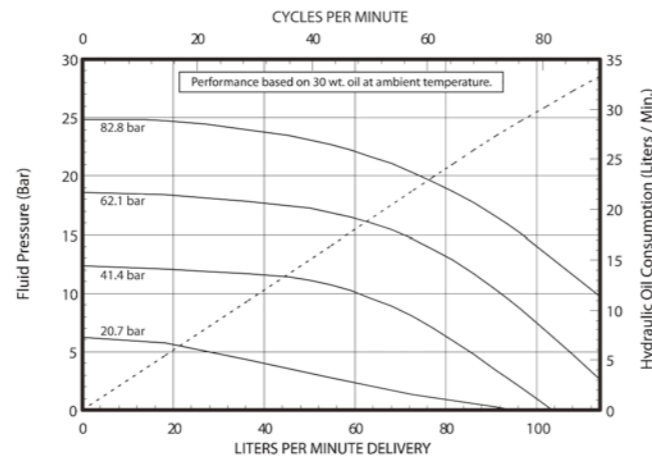
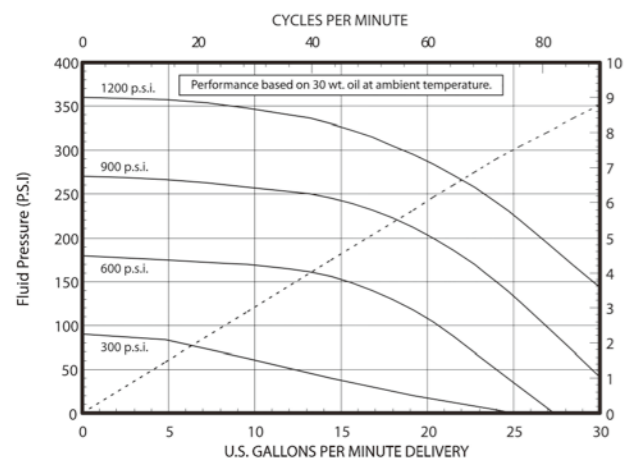

0.58:1

11.9 l/min

Hydraulic Pumps

2-ball piston pump

| Specifications | | | |
|-----------------|----------------|-------------|-----------------------------|
| ?:1 | 0.58:1 | Max. bar | 5.9 - 141.7 bar |
| Motor | 2.062" (52 mm) | Cycle/min. | 50 cycles/min. |
| Motor | 6" (152 mm) | 1 min. | 11.9 l/min. @50 cycles/min. |
| AIR | 3/8" NPT(F) | 1 cycle | 237.6 cc |
| Max. bar | 3.4 - 82.8 bar | For 1 litre | 4.2 cycle |
| OIL | 1/2" NPT(F) | | 1 1/2" NPT(F) / 2" NPT(M) |
| Max. °C | 54 °C | | 1" NPT(F) |
| Weight | 18.7 kg | | |

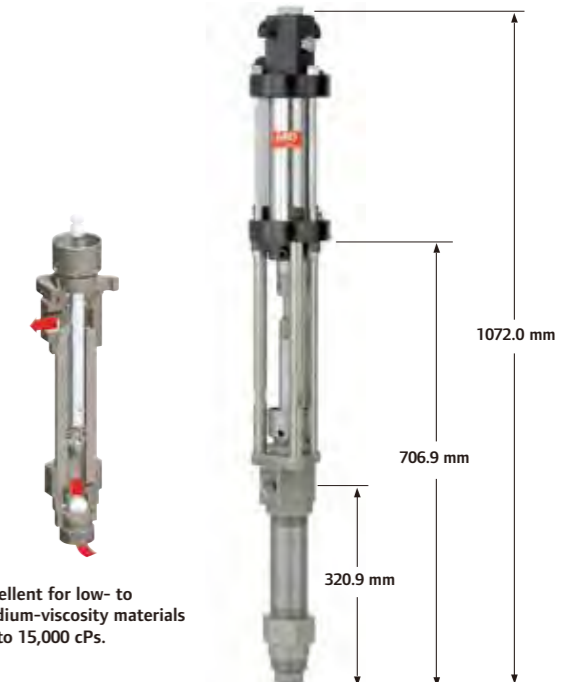

| Pump model no. | Lower pump | Plunger material | Packings (upper + lower) | ServiceKit (1) | |
|----------------|------------|--|------------------------------------|-----------------------------------|------------|
| 650943-343-B | 66300-343 | 300 Series stainless steel with tungstene carbide seat | 17-4 stainless steel / hard chrome | Glass-filled PTFE (upper & lower) | 637305-343 |

(1) Lower pump repair kit

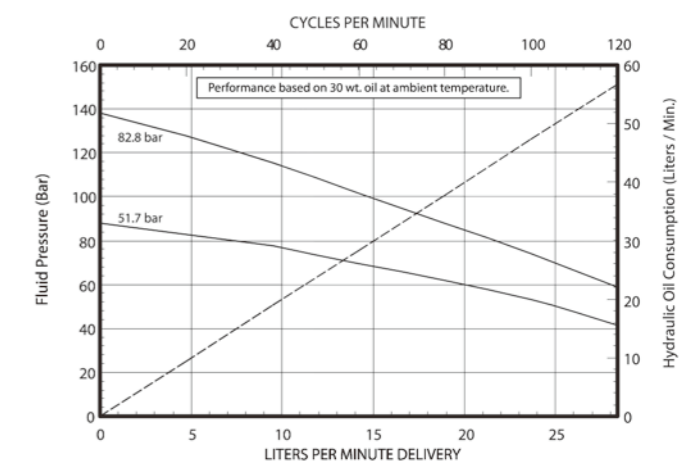
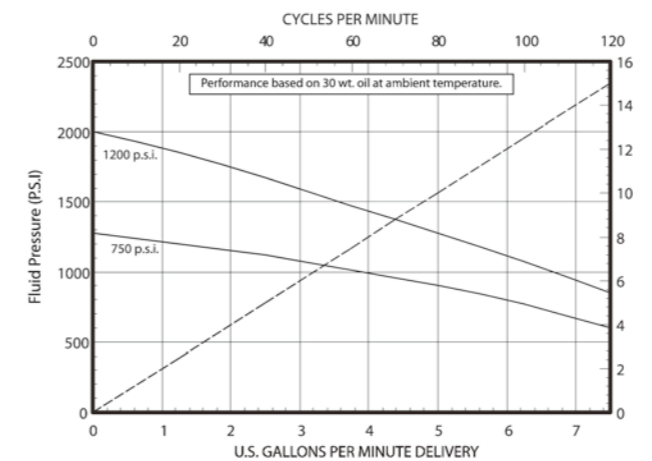

0.8:1

48.8 l/min

Hydraulic Pumps

2-ball piston pump

| Specifications | | | |
|-----------------|-----------------|------------|-----------------------------|
| ?:1 | 0.8:1 | Max. bar | 2.8 - 110.3 bar |
| Motor | 4.125" (105 mm) | Cycle/min. | 50 cycles/min. |
| Motor | 6" (152 mm) | 1 min. | 48.8 l/min. @50 cycles/min. |
| AIR | 1/2" NPT(F) | 1 cycle | 976.6 cc |
| Max. bar | 3.4 - 137.9 bar | For 1litre | 1 cycle |
| OIL | 3/4" NPT(F) | | 2" NPT(M) |
| Max. °C | 54°C | | 1 1/4" NPT(F) |
| Weight | 63.5 kg | | |



Excellent for low- to medium-viscosity materials up to 12,500 cPs.

1.2:1

33.1 l/min

Hydraulic Pumps

Chop check extrusion pump

| Specifications | | | |
|-----------------|-----------------|------------|-----------------------------|
| ?:1 | 1.2:1 | Max. bar | 4.1 - 184.1 bar |
| Motor | 4.125" (105 mm) | Cycle/min. | 50 cycles/min. |
| Motor | 6" (152 mm) | 1 min. | 33.1 l/min. @50 cycles/min. |
| AIR | 1/2" NPT(F) | 1 cycle | 648.7 cc |
| Max. bar | 3.4 - 137.9 bar | For 1litre | 1.5 cycle |
| OIL | 3/4" NPT(F) | | Flange mount |
| Max. °C | 54°C | | 1 1/2" NPT(F) |
| Weight | 65.3 kg | | |



Capable of moving medium- to high-viscosity fluids ranging from 15,000 to more than 125,000 cPs.

| Pump model no. | Lower pump | Plunger material | Packings (upper + lower) | ServiceKit (1) |
|----------------|------------|--|---|----------------|
| 650940-C6D | 66941-C6D | 400 stainless steel | UHMW-PE +UHMW-PE | 637211-C63 |
| 650940-L6D | 66941-L6D | | Mineral-filled PTFE (upper & lower) | 637211-L63 |
| 650940-P6D | 66941-P6D | | UHMW-PE/glass-filled PTFE + UHMW-PE | 637211-P63 |
| 650940-R6D | 66941-R6D | | Glass-filled PTFE / UHMW-PE staggered + Virgin PTFE | 637211-R63 |
| 650940-CDD | 66941-CDD | 15-5 stainless steel / hard chrome | UHMW-PE +UHMW-PE | 637211-C63 |
| 650940-LDD | 66941-LDD | | Mineral-filled PTFE (upper & lower) | 637211-L63 |
| 650940-PDD | 66941-PDD | | UHMW-PE/glass-filled PTFE + UHMW-PE | 637211-P63 |
| 650940-RDD | 66941-RDD | | Glass-filled PTFE / UHMW-PE staggered + Virgin PTFE | 637211-R63 |
| | | 400 Series stainless steel with tungstene carbide seat | | |

| Pump model no. | Lower pump | Plunger material | Packings (upper + lower) | ServiceKit (1) | |
|----------------|-------------|-----------------------------|----------------------------|---------------------------------------|--------------|
| 650941-F4E-C | 66236-F4E-B | Carbon steel, nickel plated | Carbon steel / hard chrome | UHMW-PE / Leather staggered + UHMW-PE | 637128-F44-B |

(1) Lower pump repair kit

(1) Lower pump repair kit

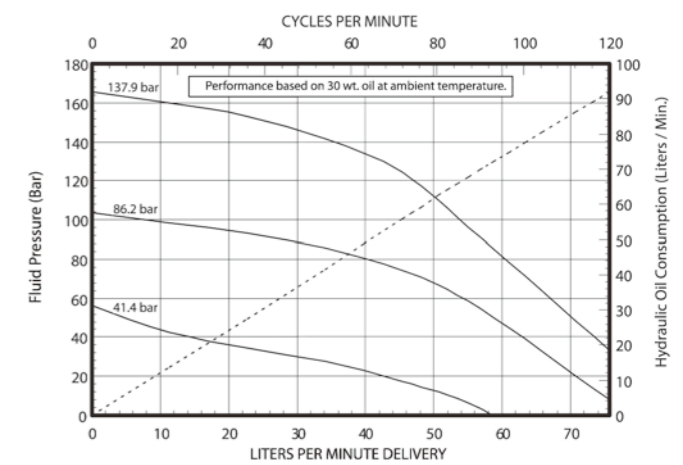
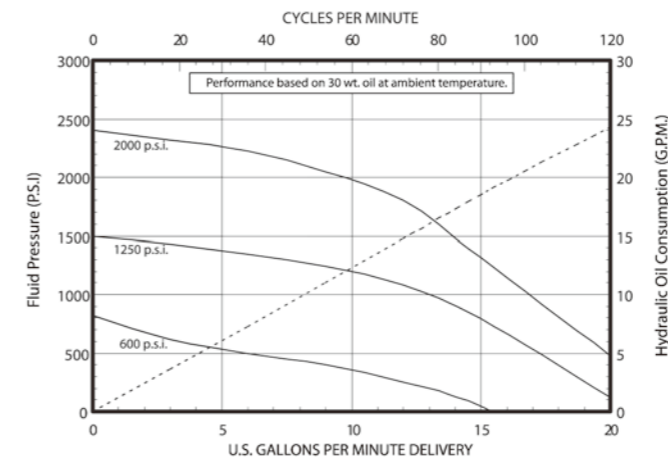
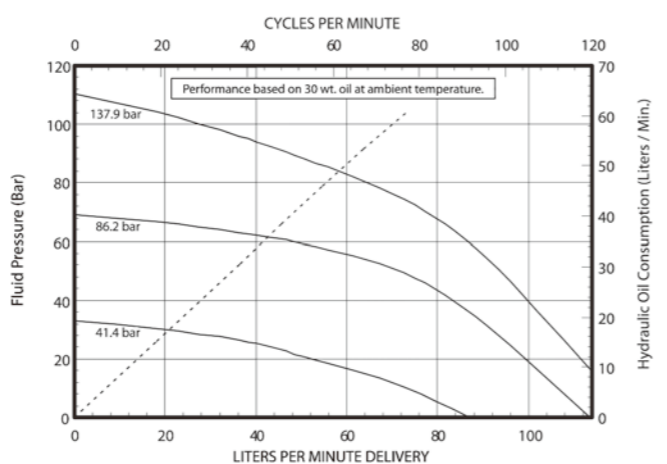
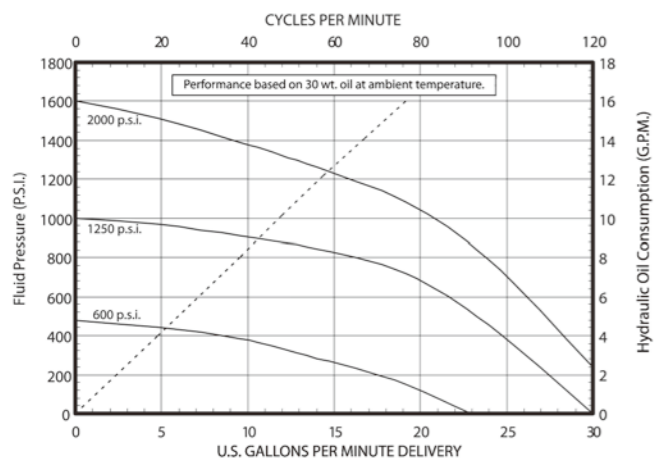

2:1
10.2 l/min

Hydraulic Pumps

Chop check extrusion pump

| Specifications | | | |
|-----------------|----------------|-------------|-----------------------------|
| ?:1 | 2:1 | Max. bar | 6.9 - 165.5 bar |
| Motor | 2.026" (52 mm) | Cycle/min. | 50 cycles/min. |
| Motor | 6" (152 mm) | 1 min. | 10.2 l/min. @50 cycles/min. |
| AIR | 3/8" NPT(F) | 1 cycle | 204.8 cc |
| Max. bar | 3.4 - 82.8 bar | For 1 litre | 4.8 cycle |
| OIL | 1/2" NPT(F) | | Flange mount |
| Max. °C | 54 °C | | 1" NPT(F) |
| Weight | 28.3 kg | | |

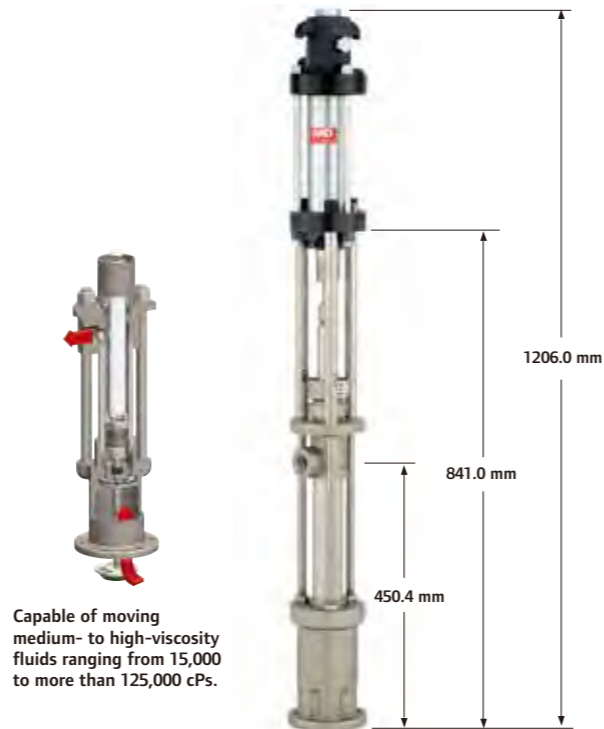

| Pump model no. | Lower pump | Plunger material | Packings (upper + lower) | ServiceKit (1) | |
|----------------|-------------|-----------------------------|------------------------------------|---|--------------|
| 650934-G43-C | 66243-G43-B | Carbon steel, nickel plated | 17-4 stainless steel / hard chrome | UHMW-PE / Leather staggered (upper & lower) | 637071-G43-B |

(1) Lower pump repair kit

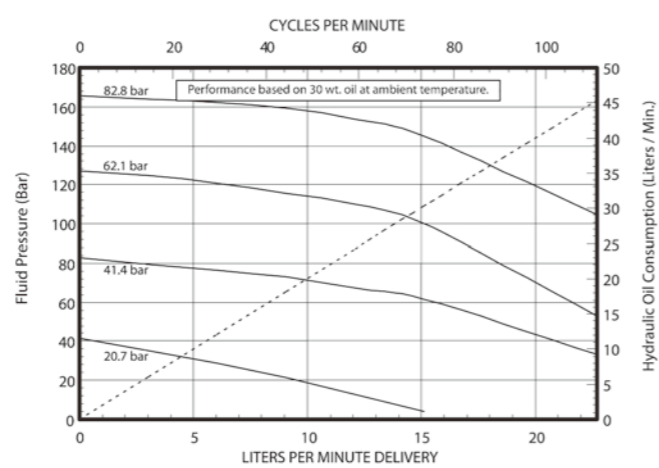
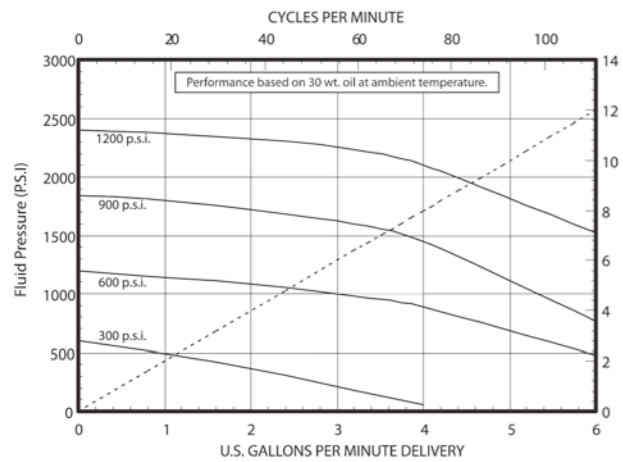

3.3:1
6.1 l/min

Hydraulic Pumps

2-ball piston pump

| Specifications | | | |
|-----------------|----------------|-------------|----------------------------|
| ?:1 | 3.3:1 | Max. bar | 11.4 - 275.4 bar |
| Motor | 2.062" (52 mm) | Cycle/min. | 50 cycles/min. |
| Motor | 6" (152 mm) | 1 min. | 6.1 l/min. @50 cycles/min. |
| AIR | 3/8" NPT(F) | 1 cycle | 121.2 cc |
| Max. bar | 3.4 - 82.8 bar | For 1 litre | 8.2 cycle |
| OIL | 1/2" NPT(F) | | 1 1/2" NPT(F) / 2" NPT(M) |
| Max. °C | 54 °C | | 1" NPT(F) |
| Weight | 18.7 kg | | |

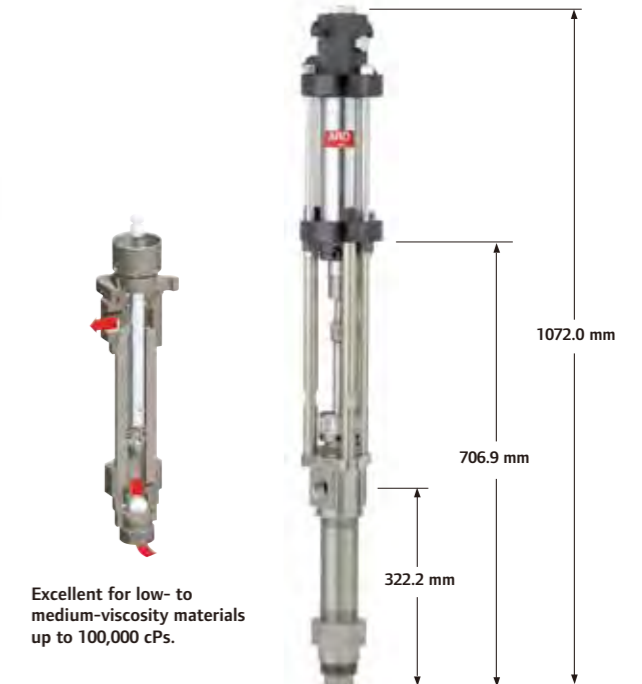

| Pump model no. | Lower pump | Plunger material | Packings (upper + lower) | ServiceKit (1) | |
|----------------|------------|--|------------------------------------|-------------------|------------|
| 650944-C43-C | 66301-C43 | 300 Series stainless steel with tungstene carbide seat | 17-4 stainless steel / hard chrome | UHMW-PE + UHMW-PE | 637306-C43 |

(1) Lower pump repair kit

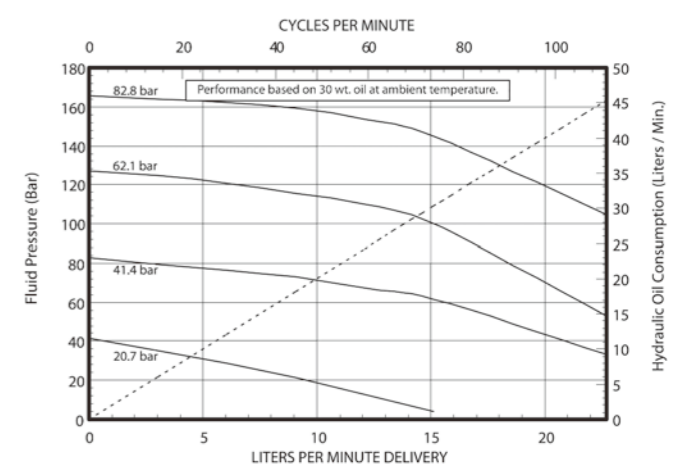
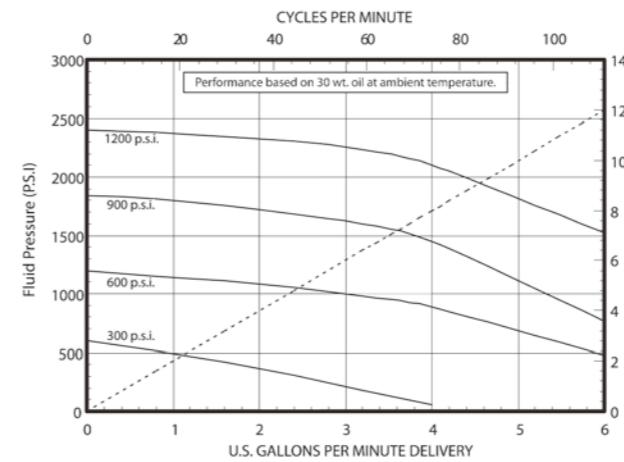

3.6:1

5.7 l/min

Hydraulic Pumps

Chop check extrusion pump

| Specifications | | | |
|----------------|----------------|-------------|----------------------------|
| ?:1 | 3.6:1 | Max. bar | 12.4 - 297.9 bar |
| Motor | 2.026" (52 mm) | Cycle/min. | 50 cycles/min. |
| Motor | 6" (152 mm) | 1 min. | 5.7 l/min. @50 cycles/min. |
| AIR | 3/8" NPT(F) | 1 cycle | 113.0 cc |
| Max. bar | 3.4 - 82.8 bar | For 1 litre | 8.8 cycle |
| OIL | 1/2" NPT(F) | | Flange mount |
| Max. °C | 54 °C | | 1" NPT(F) |
| | 28.2 kg | | |

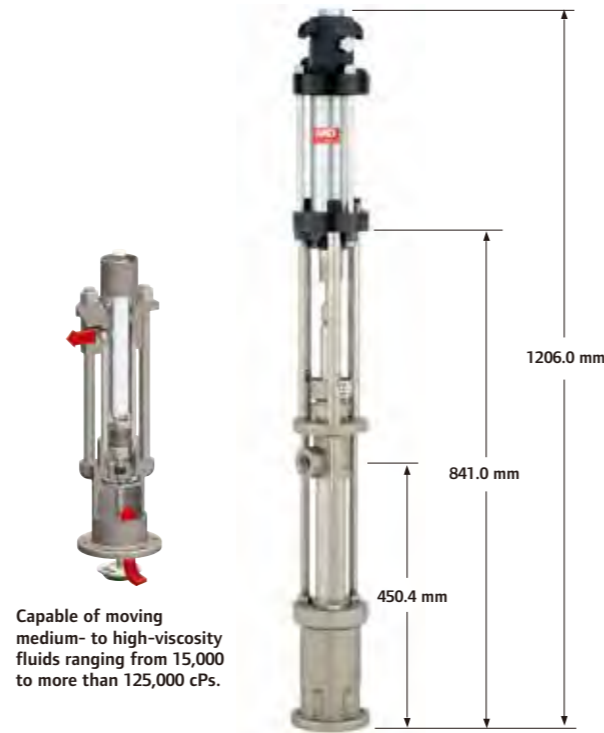

| Pump model no. | Lower pump | Plunger material | Packings (upper + lower) | ServiceKit (1) | |
|----------------|-------------|-----------------------------|------------------------------------|-------------------|--------------|
| 650935-C43-C | 66266-C43-B | Carbon steel, nickel plated | 17-4 stainless steel / hard chrome | UHMW-PE + UHMW-PE | 637074-C43-B |

(1) Lower pump repair kit

